

**Miniature circuit-breakers
for branch circuit protection
according to UL 489,
CSA C 22.2 No. 5**



When connecting aluminum conductors, ensure that the contact surfaces of the conductors are cleaned, brushed and greased.

For finely stranded conductors, use a connector sleeve for best results.

Conditions for Delivery and Sale

For domestic business, the Standard Terms for Delivery of Products and Services of the Electrical Industry (ABB Form 2292) shall apply in connection with the Standard Sale Terms (ABB Form 2327) in their then applicable version. For foreign business, the Standard Terms for Delivery of Products and Services of the Electrical Industry (ABB Form 2293 German-English, or ABB-Form 2294 German- French) shall apply in connection with the Standard Sale Terms (ABB-Form 2381 English) in their then applicable version.

Warranty

We assume warranty in accordance with the Standard Sale and Delivery Terms. Complaints shall be made in writing within eight days following receipt of the goods.

Technical information and illustrations are not binding and subject to change without notice.

Contents	Page
Overall view	4
Selection table S 201 DC, 60 V DC/AC	6
Selection table S 200 U, 120/240 V AC	7
Selection table S 200 UP, 277/480 V AC	11
Supplementary devices	13
Planning notes	14
Technical data S 201 DC	15
Tripping characteristics, Let-through value diagrams	16
Internal resistance, Dimension drawings, Connection diagrams	17
Technical data S 200 U, S 200 UP	18
Short circuit capacity	19
Internal resistance, Let-through value diagrams	20
Tripping characteristics, Ambient temperature	21
Busbars and accessories	22
Applications	23

The new generation of miniature circuit breakers.

System **pro M compact**[®] S 200 Series.



The new S 200 Series cover all your circuit breaker needs up to 63 amps. We have redesigned our popular supplementary protectors and additionally introduce now a brand new range of miniature molded case circuit breakers suitable for use as branch circuit protection according to UL 489.

Alongside the redesigned S 200 and S 200 P supplementary protectors; the new S 200 U and S 200 UP miniature MCCBs offer the familiar ABB advantages; small size, exemplary protection and easy installation with double terminal technologie.

S200 U and UP series are UL 489, CSA C 22.2 No. 5 approved as well as IEC 947-2. For the first time one circuit breaker fulfills North American and global approval requirements. Global circuit breakers for OEMs building global equipment.

The new S 200 Series is the first truly compact and modular full circuit breaker solution for use in both North American and global markets.



Signal contacts S2C-S6RU

It signals the tripping caused by overload earth fault or short circuit current however there is no signal when the M.C.B. is switched OFF manually. With a red handle which allows resetting of the trip signal without the M.C.B. being switched on.



Auxiliary contact S2C-H6RU

The switching position of the auxiliary contact depends on the position of the M.C.B. (ON-OFF). Because of coupling to the switching mechanism of the M.C.B. the auxiliary contact offers a trip free feature.



System **pro M compact**® - all you need ...

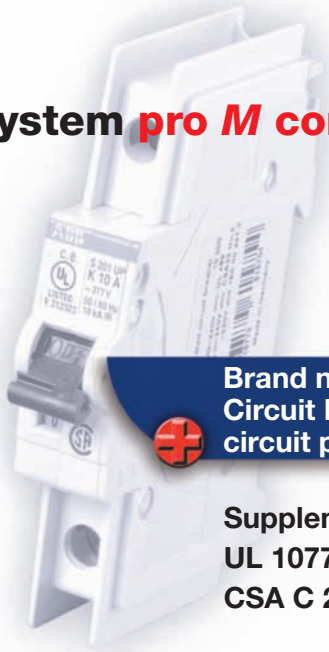

Brand new Miniature Moulded Case Circuit Breakers for use as branch circuit protection devices



**Supplemental Protective Device
UL 1077
CSA C 22.2 No. 235**

**Branch Circuit Protector
UL 489 / UL 489 A
CSA C 22.2 No. 5**

The S 200 U/S 200 UP components are modular and cover voltages and currents used worldwide, including 240 VΔ (S 200 U), 480Y/277 V (S 200 UP) in the US and the 230/400 V IEC standard, with models catering to the full range of current 0.2 – 63 A. For control circuits of the production range S 201 DC to 60 V AC/DC.



	S 200	S 200 P	S 201 DC	S 200 U	S 200 UP
Amperage	0.5 – 63 A	0.2 – 63 A	1 – 25 A	0.2 – 63 A	0.2 – 25 A
Voltage	480Y /277 V AC	480Y /277 V AC	60 V AC DC	240 V AC	480Y /277 V AC
Poles	1-, 2-, 3-, 4-poles	1-, 2-, 3-, 4-poles	1-poles	1-, 2-, 3-, 4-poles	1-, 2-, 3-, 4-poles
Trip characteristics	B, C, D, K, Z	B, C, D, K, Z	K, Z	K, Z	K, Z
Approvals	6 kA : IEC 60898* 6 kA : CSAC22.2No.235 6 kA : UL 1077	>10 kA : IEC 947-2* 10 kA : CSAC22.2No.235 10 kA : UL 1077	10 kA : IEC 947-2 10 kA : UL 489	10 kA : IEC 947-2* 10 kA : CSAC22.2No. 5 10 kA : UL 489	10 kA : IEC 947-2* 10 kA : CSAC22.2No. 5 10 kA : UL 489

* IEC ratings at 230/400 V AC

Selection table

No. of poles	Rated current I_n A	Ordering details		bbn 40 16779 EAN	Price 1 piece €	Price group	Weight 1 piece kg	Pack. unit pcs.	
		Type No.	Order code						
1	1	S201 DC-K 1	2CDS 271 217 R0217	58412 8			0.125	10	
	1.6	S201 DC-K 1.6	2CDS 271 217 R0257	58466 1			0.125	10	
	2	S201 DC-K 2	2CDS 271 217 R0277	58413 5			0.125	10	
	3	S201 DC-K 3	2CDS 271 217 R0317	58414 2			0.125	10	
	4	S201 DC-K 4	2CDS 271 217 R0337	58415 9			0.125	10	
	6	S201 DC-K 6	2CDS 271 217 R0377	58416 6			0.125	10	
	8	S201 DC-K 8	2CDS 271 217 R0407	58417 3			0.125	10	
	10	S201 DC-K 10	2CDS 271 217 R0427	58418 0			0.125	10	
	13	S201 DC-K 13	2CDS 271 217 R0447	58419 7			0.125	10	
	U_{Bmax} 60 V~ 60 V...	16	S201 DC-K 16	2CDS 271 217 R0467	58420 3			0.125	10
		20	S201 DC-K 20	2CDS 271 217 R0487	58421 0			0.125	10
		25	S201 DC-K 25	2CDS 271 217 R0517	58422 7			0.125	10
	1	1	S201 DC-Z 1	2CDS 271 217 R0218	58425 8			0.125	10
1.6		S201 DC-Z 1.6	2CDS 271 217 R0258	58426 5			0.125	10	
2		S201 DC-Z 2	2CDS 271 217 R0278	58427 2			0.125	10	
3		S201 DC-Z 3	2CDS 271 217 R0318	58428 9			0.125	10	
4		S201 DC-Z 4	2CDS 271 217 R0338	58429 6			0.125	10	
6		S201 DC-Z 6	2CDS 271 217 R0378	58430 2			0.125	10	
8		S201 DC-Z 8	2CDS 271 217 R0408	58431 9			0.125	10	
10		S201 DC-Z 10	2CDS 271 217 R0428	58432 6			0.125	10	
U_{Bmax} 60 V~ 60 V...		16	S201 DC-Z 16	2CDS 271 217 R0468	58433 3			0.125	10
		20	S201 DC-Z 20	2CDS 271 217 R0488	58434 0			0.125	10
		25	S201 DC-Z 25	2CDS 271 217 R0518	58435 7			0.125	10
1		1	S201 DC-K 1 H10	2CDV 271 217 R0217	58436 4			0.125	6
		1.6	S201 DC-K 1.6 H10	2CDV 271 217 R0257	58437 1			0.125	6
	2	S201 DC-K 2 H10	2CDV 271 217 R0277	58438 8			0.125	6	
	3	S201 DC-K 3 H10	2CDV 271 217 R0317	58439 5			0.125	6	
	4	S201 DC-K 4 H10	2CDV 271 217 R0337	58440 1			0.125	6	
	6	S201 DC-K 6 H10	2CDV 271 217 R0377	58441 8			0.125	6	
	8	S201 DC-K 8 H10	2CDV 271 217 R0407	58442 5			0.125	6	
	10	S201 DC-K 10 H10	2CDV 271 217 R0427	58443 2			0.125	6	
	13	S201 DC-K 13 H10	2CDV 271 217 R0447	58444 9			0.125	6	
	U_{Bmax} 60 V~ 60 V...	16	S201 DC-K 16 H10	2CDV 271 217 R0467	58445 6			0.125	6
		20	S201 DC-K 20 H10	2CDV 271 217 R0487	58446 3			0.125	6
		25	S201 DC-K 25 H10	2CDV 271 217 R0517	58447 0			0.125	6
	1	1	S201 DC-Z 1 H10	2CDV 271 217 R0218	58448 7			0.125	6
1.6		S201 DC-Z 1.6 H10	2CDV 271 217 R0258	58449 4			0.125	6	
2		S201 DC-Z 2 H10	2CDV 271 217 R0278	58450 0			0.125	6	
3		S201 DC-Z 3 H10	2CDV 271 217 R0318	58494 4			0.125	6	
4		S201 DC-Z 4 H10	2CDV 271 217 R0338	58495 1			0.125	6	
6		S201 DC-Z 6 H10	2CDV 271 217 R0378	58451 7			0.125	6	
8		S201 DC-Z 8 H10	2CDV 271 217 R0408	58452 4			0.125	6	
10		S201 DC-Z 10 H10	2CDV 271 217 R0428	58453 1			0.125	6	
U_{Bmax} 60 V~ 60 V...		16	S201 DC-Z 16 H10	2CDV 271 217 R0468	58496 8			0.125	6
		20	S201 DC-Z 20 H10	2CDV 271 217 R0488	58454 8			0.125	6
		25	S201 DC-Z 25 H10	2CDV 271 217 R0518	58455 5			0.125	6



S201 DC-K 25

2CDC 021 408 F0003



S201 DC-Z 4 H10

2CDC 021 409 F0003

K

10000



2CDC 021 314 F0004



2CDC 021 315 F0004

Selection table

No. of poles	Rated current I _n , A	Ordering details	Order code	bbn 40 16779 EAN	Price 1 piece €	Price group	Weight 1 piece kg	Pack. unit pcs.
1	0.2	S 201 U-K 0.2	2CDS 271 417 R0087	61922 6			0.14	10
	0.3	S 201 U-K 0.3	2CDS 271 417 R0117	61923 3			0.14	10
	0.5	S 201 U-K 0.5	2CDS 271 417 R0157	61924 0			0.14	10
	0.75	S 201 U-K 0.75	2CDS 271 417 R0187	61925 7			0.14	10
	1	S 201 U-K 1	2CDS 271 417 R0217	61926 4			0.14	10
	1.6	S 201 U-K 1.6	2CDS 271 417 R0257	61927 1			0.14	10
	2	S 201 U-K 2	2CDS 271 417 R0277	61928 8			0.14	10
	3	S 201 U-K 3	2CDS 271 417 R0317	61929 5			0.14	10
	4	S 201 U-K 4	2CDS 271 417 R0337	61930 1			0.14	10
	5	S 201 U-K 5	2CDS 271 417 R0357	61931 8			0.14	10
	6	S 201 U-K 6	2CDS 271 417 R0377	61932 5			0.14	10
	8	S 201 U-K 8	2CDS 271 417 R0407	61933 2			0.14	10
	10	S 201 U-K 10	2CDS 271 417 R0427	61934 9			0.14	10
	15	S 201 U-K 15	2CDS 271 417 R0457	61936 3			0.14	10
	16	S 201 U-K 16	2CDS 271 417 R0467	61937 0			0.14	10
	20	S 201 U-K 20	2CDS 271 417 R0487	61938 7			0.14	10
	25	S 201 U-K 25	2CDS 271 417 R0517	61939 4			0.14	10
	30	S 201 U-K 30	2CDS 271 417 R0527	61940 0			0.14	10
	32	S 201 U-K 32	2CDS 271 417 R0537	61941 7			0.14	10
	40	S 201 U-K 40	2CDS 271 417 R0557	61942 4			0.14	10
	50	S 201 U-K 50	2CDS 271 417 R0577	61943 1			0.14	10
60	S 201 U-K 60	2CDS 271 417 R0587	61944 8			0.14	10	
63	S 201 U-K 63	2CDS 271 417 R0607	61945 5			0.14	10	
2	0.2	S 202 U-K 0.2	2CDS 272 417 R0087	61946 2			0.28	5
	0.3	S 202 U-K 0.3	2CDS 272 417 R0117	61947 9			0.28	5
	0.5	S 202 U-K 0.5	2CDS 272 417 R0157	61948 6			0.28	5
	0.75	S 202 U-K 0.75	2CDS 272 417 R0187	61949 3			0.28	5
	1	S 202 U-K 1	2CDS 272 417 R0217	61950 9			0.28	5
	1.6	S 202 U-K 1.6	2CDS 272 417 R0257	61951 6			0.28	5
	2	S 202 U-K 2	2CDS 272 417 R0277	61952 3			0.28	5
	3	S 202 U-K 3	2CDS 272 417 R0317	61953 0			0.28	5
	4	S 202 U-K 4	2CDS 272 417 R0337	61954 7			0.28	5
	5	S 202 U-K 5	2CDS 272 417 R0357	61955 4			0.28	5
	6	S 202 U-K 6	2CDS 272 417 R0377	61956 1			0.28	5
	8	S 202 U-K 8	2CDS 272 417 R0407	61957 8			0.28	5
	10	S 202 U-K 10	2CDS 272 417 R0427	61958 5			0.28	5
	15	S 202 U-K 15	2CDS 272 417 R0457	61960 8			0.28	5
	16	S 202 U-K 16	2CDS 272 417 R0467	61961 5			0.28	5
	20	S 202 U-K 20	2CDS 272 417 R0487	61962 2			0.28	5
	25	S 202 U-K 25	2CDS 272 417 R0517	61963 9			0.28	5
	30	S 202 U-K 30	2CDS 272 417 R0527	61964 6			0.28	5
	32	S 202 U-K 32	2CDS 272 417 R0537	61965 3			0.28	5
	40	S 202 U-K 40	2CDS 272 417 R0557	61966 0			0.28	5
	50	S 202 U-K 50	2CDS 272 417 R0577	61967 7			0.28	5
60	S 202 U-K 60	2CDS 272 417 R0587	61968 4			0.28	5	
63	S 202 U-K 63	2CDS 272 417 R0607	61969 1			0.28	5	

K

10000



2CDC 021 316 F0004



2CDC 021 317 F0004

Selection table

No. of poles	Rated current I _n A	Ordering details		bbn 40 16779 EAN	Price 1 piece €	Price group	Weight 1 piece kg	Pack. unit pcs.
		Type No.	Order code					
3	0.2	S 203 U-K 0.2	2CDS 273 417 R0087	61970 7			0.42	3
	0.3	S 203 U-K 0.3	2CDS 273 417 R0117	61971 4			0.42	3
	0.5	S 203 U-K 0.5	2CDS 273 417 R0157	61972 1			0.42	3
	0.75	S 203 U-K 0.75	2CDS 273 417 R0187	61973 8			0.42	3
	1	S 203 U-K 1	2CDS 273 417 R0217	61974 5			0.42	3
	1.6	S 203 U-K 1.6	2CDS 273 417 R0257	61975 2			0.42	3
	2	S 203 U-K 2	2CDS 273 417 R0277	61976 9			0.42	3
	3	S 203 U-K 3	2CDS 273 417 R0317	61977 6			0.42	3
	4	S 203 U-K 4	2CDS 273 417 R0337	61978 3			0.42	3
	5	S 203 U-K 5	2CDS 273 417 R0357	61979 0			0.42	3
	6	S 203 U-K 6	2CDS 273 417 R0377	61980 6			0.42	3
	8	S 203 U-K 8	2CDS 273 417 R0407	61981 3			0.42	3
	10	S 203 U-K 10	2CDS 273 417 R0427	61982 0			0.42	3
	15	S 203 U-K 15	2CDS 273 417 R0457	61984 4			0.42	3
	16	S 203 U-K 16	2CDS 273 417 R0467	61985 1			0.42	3
	20	S 203 U-K 20	2CDS 273 417 R0487	61986 8			0.42	3
	25	S 203 U-K 25	2CDS 273 417 R0517	61987 5			0.42	3
30	S 203 U-K 30	2CDS 273 417 R0527	61988 2			0.42	3	
32	S 203 U-K 32	2CDS 273 417 R0537	61989 9			0.42	3	
40	S 203 U-K 40	2CDS 273 417 R0557	61990 5			0.42	3	
50	S 203 U-K 50	2CDS 273 417 R0577	61991 2			0.42	3	
60	S 203 U-K 60	2CDS 273 417 R0587	61992 9			0.42	3	
63	S 203 U-K 63	2CDS 273 417 R0607	61993 6			0.42	3	
4	0.2	S 204 U-K 0.2	2CDS 274 417 R0087	61994 3			0.56	2
	0.3	S 204 U-K 0.3	2CDS 274 417 R0117	61995 0			0.56	2
	0.5	S 204 U-K 0.5	2CDS 274 417 R0157	61996 7			0.56	2
	0.75	S 204 U-K 0.75	2CDS 274 417 R0187	61997 4			0.56	2
	1	S 204 U-K 1	2CDS 274 417 R0217	61998 1			0.56	2
	1.6	S 204 U-K 1.6	2CDS 274 417 R0257	61999 8			0.56	2
	2	S 204 U-K 2	2CDS 274 417 R0277	62000 0			0.56	2
	3	S 204 U-K 3	2CDS 274 417 R0317	62001 7			0.56	2
	4	S 204 U-K 4	2CDS 274 417 R0337	62002 4			0.56	2
	5	S 204 U-K 5	2CDS 274 417 R0357	62003 1			0.56	2
	6	S 204 U-K 6	2CDS 274 417 R0377	62004 8			0.56	2
	8	S 204 U-K 8	2CDS 274 417 R0407	62005 5			0.56	2
	10	S 204 U-K 10	2CDS 274 417 R0427	62006 2			0.56	2
	15	S 204 U-K 15	2CDS 274 417 R0457	62008 6			0.56	2
	16	S 204 U-K 16	2CDS 274 417 R0467	62009 3			0.56	2
	20	S 204 U-K 20	2CDS 274 417 R0487	62010 9			0.56	2
	25	S 204 U-K 25	2CDS 274 417 R0517	62011 6			0.56	2
30	S 204 U-K 30	2CDS 274 417 R0527	62012 3			0.56	2	
32	S 204 U-K 32	2CDS 274 417 R0537	62013 0			0.56	2	
40	S 204 U-K 40	2CDS 274 417 R0557	62014 7			0.56	2	
50	S 204 U-K 50	2CDS 274 417 R0577	62015 4			0.56	2	
60	S 204 U-K 60	2CDS 274 417 R0587	62016 1			0.56	2	
63	S 204 U-K 63	2CDS 274 417 R0607	62017 8			0.56	2	

Z

10 000



2CDC 021 314 F0004



2CDC 021 315 F0004

Selection table

No. of poles	Rated current I _n , A	Ordering details		bbn 40 16779 EAN	Price 1 piece €	Price group	Weight 1 piece kg	Pack. unit pcs.
		Type No.	Order code					
1	0.5	S 201 U-Z 0.5	2CDS 271 417 R0158	620185			0.14	10
	1	S 201 U-Z 1	2CDS 271 417 R0218	620192			0.14	10
	1.6	S 201 U-Z 1.6	2CDS 271 417 R0258	620208			0.14	10
	2	S 201 U-Z 2	2CDS 271 417 R0278	620215			0.14	10
	3	S 201 U-Z 3	2CDS 271 417 R0318	620222			0.14	10
	4	S 201 U-Z 4	2CDS 271 417 R0338	620239			0.14	10
	5	S 201 U-Z 5	2CDS 271 417 R0358	620246			0.14	10
	6	S 201 U-Z 6	2CDS 271 417 R0378	620253			0.14	10
	8	S 201 U-Z 8	2CDS 271 417 R0408	620260			0.14	10
	10	S 201 U-Z 10	2CDS 271 417 R0428	620277			0.14	10
	15	S 201 U-Z 15	2CDS 271 417 R0458	620291			0.14	10
	16	S 201 U-Z 16	2CDS 271 417 R0468	620307			0.14	10
	20	S 201 U-Z 20	2CDS 271 417 R0488	620314			0.14	10
	25	S 201 U-Z 25	2CDS 271 417 R0518	620321			0.14	10
	30	S 201 U-Z 30	2CDS 271 417 R0528	622851			0.14	10
	32	S 201 U-Z 32	2CDS 271 417 R0538	620345			0.14	10
	40	S 201 U-Z 40	2CDS 271 417 R0558	620352			0.14	10
	50	S 201 U-Z 50	2CDS 271 417 R0578	620369			0.14	10
60	S 201 U-Z 60	2CDS 271 417 R0588	620376			0.14	10	
63	S 201 U-Z 63	2CDS 271 417 R0608	620383			0.14	10	
2	0.5	S 202 U-Z 0.5	2CDS 272 417 R0158	620390			0.28	5
	1	S 202 U-Z 1	2CDS 272 417 R0218	620406			0.28	5
	1.6	S 202 U-Z 1.6	2CDS 272 417 R0258	620413			0.28	5
	2	S 202 U-Z 2	2CDS 272 417 R0278	620420			0.28	5
	3	S 202 U-Z 3	2CDS 272 417 R0318	620437			0.28	5
	4	S 202 U-Z 4	2CDS 272 417 R0338	620444			0.28	5
	5	S 202 U-Z 5	2CDS 272 417 R0358	620451			0.28	5
	6	S 202 U-Z 6	2CDS 272 417 R0378	620468			0.28	5
	8	S 202 U-Z 8	2CDS 272 417 R0408	620475			0.28	5
	10	S 202 U-Z 10	2CDS 272 417 R0428	620482			0.28	5
	15	S 202 U-Z 15	2CDS 272 417 R0458	620505			0.28	5
	16	S 202 U-Z 16	2CDS 272 417 R0468	620512			0.28	5
	20	S 202 U-Z 20	2CDS 272 417 R0488	620529			0.28	5
	25	S 202 U-Z 25	2CDS 272 417 R0518	620536			0.28	5
	30	S 202 U-Z 30	2CDS 272 417 R0528	620543			0.28	5
	32	S 202 U-Z 32	2CDS 272 417 R0538	620550			0.28	5
	40	S 202 U-Z 40	2CDS 272 417 R0558	620567			0.28	5
	50	S 202 U-Z 50	2CDS 272 417 R0578	620574			0.28	5
60	S 202 U-Z 60	2CDS 272 417 R0588	620581			0.28	5	
63	S 202 U-Z 63	2CDS 272 417 R0608	620598			0.28	5	

Z

10000



2CDC 021 316 F0004



2CDC 021 317 F0004

Selection table

No. of poles	Rated current I _n A	Ordering details		bbn 40 16779 EAN	Price 1 piece €	Price group	Weight 1 piece kg	Pack. unit pcs.
		Type No.	Order code					
3	0.5	S 203 U-Z 0.5	2CDS 273 417 R0158	620604			0.42	3
	1	S 203 U-Z 1	2CDS 273 417 R0218	620611			0.42	3
	1.6	S 203 U-Z 1.6	2CDS 273 417 R0258	620628			0.42	3
	2	S 203 U-Z 2	2CDS 273 417 R0278	620635			0.42	3
	3	S 203 U-Z 3	2CDS 273 417 R0318	620642			0.42	3
	4	S 203 U-Z 4	2CDS 273 417 R0338	620659			0.42	3
	5	S 203 U-Z 5	2CDS 273 417 R0358	620666			0.42	3
	6	S 203 U-Z 6	2CDS 273 417 R0378	620673			0.42	3
	8	S 203 U-Z 8	2CDS 273 417 R0408	620680			0.42	3
	10	S 203 U-Z 10	2CDS 273 417 R0428	620697			0.42	3
	15	S 203 U-Z 15	2CDS 273 417 R0458	620710			0.42	3
	16	S 203 U-Z 16	2CDS 273 417 R0468	620727			0.42	3
	20	S 203 U-Z 20	2CDS 273 417 R0488	620734			0.42	3
	25	S 203 U-Z 25	2CDS 273 417 R0518	620741			0.42	3
	30	S 203 U-Z 30	2CDS 273 417 R0528	620758			0.42	3
	32	S 203 U-Z 32	2CDS 273 417 R0538	620765			0.42	3
	40	S 203 U-Z 40	2CDS 273 417 R0558	620772			0.42	3
50	S 203 U-Z 50	2CDS 273 417 R0578	620789			0.42	3	
60	S 203 U-Z 60	2CDS 273 417 R0588	620796			0.42	3	
63	S 203 U-Z 63	2CDS 273 417 R0608	620802			0.42	3	
4	0.5	S 204 U-Z 0.5	2CDS 274 417 R0158	620819			0.56	2
	1	S 204 U-Z 1	2CDS 274 417 R0218	620826			0.56	2
	1.6	S 204 U-Z 1.6	2CDS 274 417 R0258	620833			0.56	2
	2	S 204 U-Z 2	2CDS 274 417 R0278	620840			0.56	2
	3	S 204 U-Z 3	2CDS 274 417 R0318	620857			0.56	2
	4	S 204 U-Z 4	2CDS 274 417 R0338	620864			0.56	2
	5	S 204 U-Z 5	2CDS 274 417 R0358	620871			0.56	2
	6	S 204 U-Z 6	2CDS 274 417 R0378	620888			0.56	2
	8	S 204 U-Z 8	2CDS 274 417 R0408	620895			0.56	2
	10	S 204 U-Z 10	2CDS 274 417 R0428	620901			0.56	2
	15	S 204 U-Z 15	2CDS 274 417 R0458	620925			0.56	2
	16	S 204 U-Z 16	2CDS 274 417 R0468	620932			0.56	2
	20	S 204 U-Z 20	2CDS 274 417 R0488	620949			0.56	2
	25	S 204 U-Z 25	2CDS 274 417 R0518	620956			0.56	2
	30	S 204 U-Z 30	2CDS 274 417 R0528	620963			0.56	2
	32	S 204 U-Z 32	2CDS 274 417 R0538	620970			0.56	2
	40	S 204 U-Z 40	2CDS 274 417 R0558	620987			0.56	2
50	S 204 U-Z 50	2CDS 274 417 R0578	620994			0.56	2	
60	S 204 U-Z 60	2CDS 274 417 R0588	621007			0.56	2	
63	S 204 U-Z 63	2CDS 274 417 R0608	621014			0.56	2	

K

10000



2CDC 021 318 F0004



2CDC 021 319 F0004



2CDC 021 320 F0004



2CDC 023 321 F0004

Selection table

No. of poles	Rated current I _n , A	Ordering details	Order code	bbn 40 16779 EAN	Price 1 piece €	Price group	Weight 1 piece kg	Pack. unit pcs.
		Type No.						
1	0.2	S 201 UP-K 0.2	2CDS 271 317 R0087	61563 1			0.14	10
	0.3	S 201 UP-K 0.3	2CDS 271 317 R0117	61564 8			0.14	10
	0.5	S 201 UP-K 0.5	2CDS 271 317 R0157	61565 5			0.14	10
	0.75	S 201 UP-K 0.75	2CDS 271 317 R0187	61566 2			0.14	10
	1	S 201 UP-K 1	2CDS 271 317 R0217	61567 9			0.14	10
	1.6	S 201 UP-K 1.6	2CDS 271 317 R0257	61568 6			0.14	10
	2	S 201 UP-K 2	2CDS 271 317 R0277	61569 3			0.14	10
	3	S 201 UP-K 3	2CDS 271 317 R0317	61570 9			0.14	10
	4	S 201 UP-K 4	2CDS 271 317 R0337	61571 6			0.14	10
	5	S 201 UP-K 5	2CDS 271 317 R0357	61572 3			0.14	10
	6	S 201 UP-K 6	2CDS 271 317 R0377	61573 0			0.14	10
	8	S 201 UP-K 8	2CDS 271 317 R0407	61574 7			0.14	10
	10	S 201 UP-K 10	2CDS 271 317 R0427	61575 4			0.14	10
	15	S 201 UP-K 15	2CDS 271 317 R0457	61577 8			0.14	10
	16	S 201 UP-K 16	2CDS 271 317 R0467	61578 5			0.14	10
	20	S 201 UP-K 20	2CDS 271 317 R0487	61579 2			0.14	10
25	S 201 UP-K 25	2CDS 271 317 R0517	61580 8			0.14	10	
2	0.2	S 202 UP-K 0.2	2CDS 272 317 R0087	61587 7			0.28	5
	0.3	S 202 UP-K 0.3	2CDS 272 317 R0117	61588 4			0.28	5
	0.5	S 202 UP-K 0.5	2CDS 272 317 R0157	61589 1			0.28	5
	0.75	S 202 UP-K 0.75	2CDS 272 317 R0187	61590 7			0.28	5
	1	S 202 UP-K 1	2CDS 272 317 R0217	61591 4			0.28	5
	1.6	S 202 UP-K 1.6	2CDS 272 317 R0257	61592 1			0.28	5
	2	S 202 UP-K 2	2CDS 272 317 R0277	61593 8			0.28	5
	3	S 202 UP-K 3	2CDS 272 317 R0317	61594 5			0.28	5
	4	S 202 UP-K 4	2CDS 272 317 R0337	61595 2			0.28	5
	5	S 202 UP-K 5	2CDS 272 317 R0357	61596 9			0.28	5
	6	S 202 UP-K 6	2CDS 272 317 R0377	61597 6			0.28	5
	8	S 202 UP-K 8	2CDS 272 317 R0407	61598 3			0.28	5
	10	S 202 UP-K 10	2CDS 272 317 R0427	61599 0			0.28	5
	15	S 202 UP-K 15	2CDS 272 317 R0457	61601 0			0.28	5
	16	S 202 UP-K 16	2CDS 272 317 R0467	61602 7			0.28	5
	20	S 202 UP-K 20	2CDS 272 317 R0487	61603 4			0.28	5
25	S 202 UP-K 25	2CDS 272 317 R0517	61604 1			0.28	5	
3	0.2	S 203 UP-K 0.2	2CDS 273 317 R0087	61611 9			0.42	3
	0.3	S 203 UP-K 0.3	2CDS 273 317 R0117	61612 6			0.42	3
	0.5	S 203 UP-K 0.5	2CDS 273 317 R0157	61613 3			0.42	3
	0.75	S 203 UP-K 0.75	2CDS 273 317 R0187	61614 0			0.42	3
	1	S 203 UP-K 1	2CDS 273 317 R0217	61615 7			0.42	3
	1.6	S 203 UP-K 1.6	2CDS 273 317 R0257	61616 4			0.42	3
	2	S 203 UP-K 2	2CDS 273 317 R0277	61617 1			0.42	3
	3	S 203 UP-K 3	2CDS 273 317 R0317	61618 8			0.42	3
	4	S 203 UP-K 4	2CDS 273 317 R0337	61619 5			0.42	3
	5	S 203 UP-K 5	2CDS 273 317 R0357	61620 1			0.42	3
	6	S 203 UP-K 6	2CDS 273 317 R0377	61621 8			0.42	3
	8	S 203 UP-K 8	2CDS 273 317 R0407	61622 5			0.42	3
	10	S 203 UP-K 10	2CDS 273 317 R0427	61623 2			0.42	3
	15	S 203 UP-K 15	2CDS 273 317 R0457	61625 6			0.42	3
	16	S 203 UP-K 16	2CDS 273 317 R0467	61626 3			0.42	3
	20	S 203 UP-K 20	2CDS 273 317 R0487	61627 0			0.42	3
25	S 203 UP-K 25	2CDS 273 317 R0517	61628 7			0.42	3	
4	0.2	S 204 UP-K 0.2	2CDS 274 317 R0087	61635 5			0.56	2
	0.3	S 204 UP-K 0.3	2CDS 274 317 R0117	61636 2			0.56	2
	0.5	S 204 UP-K 0.5	2CDS 274 317 R0157	61637 9			0.56	2
	0.75	S 204 UP-K 0.75	2CDS 274 317 R0187	61638 6			0.56	2
	1	S 204 UP-K 1	2CDS 274 317 R0217	61639 3			0.56	2
	1.6	S 204 UP-K 1.6	2CDS 274 317 R0257	61640 9			0.56	2
	2	S 204 UP-K 2	2CDS 274 317 R0277	61641 6			0.56	2
	3	S 204 UP-K 3	2CDS 274 317 R0317	61642 3			0.56	2
	4	S 204 UP-K 4	2CDS 274 317 R0337	61643 0			0.56	2
	5	S 204 UP-K 5	2CDS 274 317 R0357	61644 7			0.56	2
	6	S 204 UP-K 6	2CDS 274 317 R0377	61645 4			0.56	2
	8	S 204 UP-K 8	2CDS 274 317 R0407	61646 1			0.56	2
	10	S 204 UP-K 10	2CDS 274 317 R0427	61647 8			0.56	2
	15	S 204 UP-K 15	2CDS 274 317 R0457	61649 2			0.56	2
	16	S 204 UP-K 16	2CDS 274 317 R0467	61650 8			0.56	2
	20	S 204 UP-K 20	2CDS 274 317 R0487	61651 5			0.56	2
	25	S 204 UP-K 25	2CDS 274 317 R0517	61652 2			0.56	2

Z

10 000



2CDC 021 318 F0004



2CDC 021 319 F0004



2CDC 021 320 F0004



2CDC 021 321 F0004

Selection table

No. of poles	Rated current I _n A	Ordering details		bbn 40 16779 EAN	Price 1 piece €	Price group	Weight 1 piece kg	Pack. unit pcs.
		Type No.	Order code					
1	0.5	S 201 UP-Z 0.5	2CDS 271 317 R0158	61659 1			0.14	10
	1	S 201 UP-Z 1	2CDS 271 317 R0218	61660 7			0.14	10
	1.6	S 201 UP-Z 1.6	2CDS 271 317 R0258	61661 4			0.14	10
	2	S 201 UP-Z 2	2CDS 271 317 R0278	61662 1			0.14	10
	3	S 201 UP-Z 3	2CDS 271 317 R0318	61663 8			0.14	10
	4	S 201 UP-Z 4	2CDS 271 317 R0338	61664 5			0.14	10
	5	S 201 UP-Z 5	2CDS 271 317 R0358	61665 2			0.14	10
	6	S 201 UP-Z 6	2CDS 271 317 R0378	61666 9			0.14	10
	8	S 201 UP-Z 8	2CDS 271 317 R0408	61667 6			0.14	10
	10	S 201 UP-Z 10	2CDS 271 317 R0428	61668 3			0.14	10
	15	S 201 UP-Z 15	2CDS 271 317 R0458	61670 6			0.14	10
	16	S 201 UP-Z 16	2CDS 271 317 R0468	61671 3			0.14	10
	20	S 201 UP-Z 20	2CDS 271 317 R0488	61672 0			0.14	10
25	S 201 UP-Z 25	2CDS 271 317 R0518	61673 7			0.14	10	
2	0.5	S 202 UP-Z 0.5	2CDS 272 317 R0158	61680 5			0.28	5
	1	S 202 UP-Z 1	2CDS 272 317 R0218	61681 2			0.28	5
	1.6	S 202 UP-Z 1.6	2CDS 272 317 R0258	61682 9			0.28	5
	2	S 202 UP-Z 2	2CDS 272 317 R0278	61683 6			0.28	5
	3	S 202 UP-Z 3	2CDS 272 317 R0318	61684 3			0.28	5
	4	S 202 UP-Z 4	2CDS 272 317 R0338	61685 0			0.28	5
	5	S 202 UP-Z 5	2CDS 272 317 R0358	61686 7			0.28	5
	6	S 202 UP-Z 6	2CDS 272 317 R0378	61687 4			0.28	5
	8	S 202 UP-Z 8	2CDS 272 317 R0408	61688 1			0.28	5
	10	S 202 UP-Z 10	2CDS 272 317 R0428	61689 8			0.28	5
	15	S 202 UP-Z 15	2CDS 272 317 R0458	61691 1			0.28	5
	16	S 202 UP-Z 16	2CDS 272 317 R0468	61692 8			0.28	5
	20	S 202 UP-Z 20	2CDS 272 317 R0488	61693 5			0.28	5
25	S 202 UP-Z 25	2CDS 272 317 R0518	61694 2			0.28	5	
3	0.5	S 203 UP-Z 0.5	2CDS 273 317 R0158	61701 7			0.42	3
	1	S 203 UP-Z 1	2CDS 273 317 R0218	61702 4			0.42	3
	1.6	S 203 UP-Z 1.6	2CDS 273 317 R0258	61703 1			0.42	3
	2	S 203 UP-Z 2	2CDS 273 317 R0278	61704 8			0.42	3
	3	S 203 UP-Z 3	2CDS 273 317 R0318	61705 5			0.42	3
	4	S 203 UP-Z 4	2CDS 273 317 R0338	61706 2			0.42	3
	5	S 203 UP-Z 5	2CDS 273 317 R0358	61707 9			0.42	3
	6	S 203 UP-Z 6	2CDS 273 317 R0378	61708 6			0.42	3
	8	S 203 UP-Z 8	2CDS 273 317 R0408	61709 3			0.42	3
	10	S 203 UP-Z 10	2CDS 273 317 R0428	61710 9			0.42	3
	15	S 203 UP-Z 15	2CDS 273 317 R0458	61712 3			0.42	3
	16	S 203 UP-Z 16	2CDS 273 317 R0468	61713 0			0.42	3
	20	S 203 UP-Z 20	2CDS 273 317 R0488	61714 7			0.42	3
25	S 203 UP-Z 25	2CDS 273 317 R0518	61715 4			0.42	3	
4	0.5	S 204 UP-Z 0.5	2CDS 274 317 R0158	61722 2			0.56	2
	1	S 204 UP-Z 1	2CDS 274 317 R0218	61723 9			0.56	2
	1.6	S 204 UP-Z 1.6	2CDS 274 317 R0258	61724 6			0.56	2
	2	S 204 UP-Z 2	2CDS 274 317 R0278	61725 3			0.56	2
	3	S 204 UP-Z 3	2CDS 274 317 R0318	61726 0			0.56	2
	4	S 204 UP-Z 4	2CDS 274 317 R0338	61727 7			0.56	2
	5	S 204 UP-Z 5	2CDS 274 317 R0358	61728 4			0.56	2
	6	S 204 UP-Z 6	2CDS 274 317 R0378	61729 1			0.56	2
	8	S 204 UP-Z 8	2CDS 274 317 R0408	61730 7			0.56	2
	10	S 204 UP-Z 10	2CDS 274 317 R0428	61731 4			0.56	2
	15	S 204 UP-Z 15	2CDS 274 317 R0458	61733 8			0.56	2
	16	S 204 UP-Z 16	2CDS 274 317 R0468	61734 5			0.56	2
	20	S 204 UP-Z 20	2CDS 274 317 R0488	61735 2			0.56	2
25	S 204 UP-Z 25	2CDS 274 317 R0518	61736 9			0.56	2	

Accessories for S 200 U/S 200 UP

Description	Order details		bbn 40 16779 EAN	Price 1 piece €	Price group	Weight 1 piece kg	Pack. unit pcs.
	Type code	Order code					
Auxiliary contact							
Auxiliary contact only for U/UP series	S2C-H6RU	2CDS 200 914 R0001	61561 7			0.035	1
Signal contact							
Signal contact only for U/UP series	S2C-S6RU	2CDS 200 924 R0001	64677 2			0.035	1
Shunt trip							
12...60 V AC/DC	S2C-A1U	2CDS 200 908 R0001	64472 3				
110...415 V AC	S2C-A2U	2CDS 200 908 R0002	64473 0				
110...250 V DC							



2CDC 021 322 F0004

S2C-H6 RU



2CDC 021 324 F0004

S2C-S6 RU



2CDC 021 146 F0005

S2C-A1 U

Connection drawings

Signal contact S2C-S6 RU

in ON and OFF position after hand operation

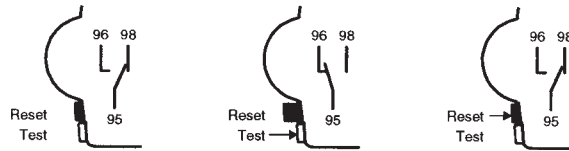

SK 0240 Z 02

in OFF position after tripping



SK 0242 Z 02

Auxiliary contact

Auxiliary contact in ON position



2CDC 092 047 F0005

Auxiliary contact in OFF position

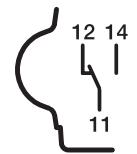

2CDC 092 048 F0005

Miniature circuit breaker

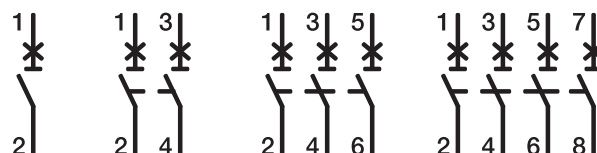

2CDC 022 049 F0005

Feeder optional, top or bottom..
Terminal designation acc. to EN 50 005.

Shunt trip



S2C-A1 U
S2C-A2 U

2CDC 092 046 F0005

Series type S 201 DC-K and S 201 DC-Z with or without integrated auxiliary switch

This series – 1-pole with K- and Z-type characteristics for 60 V AC/DC – has been designed for control circuits in machinery and plant that have to meet the requirements provided for in **UL 489**, i.e. **branch circuit protection**.

Planning notes

Overcurrent protection according to EN 60 204-1, protection of damageable components:

A high degree of protection is only possible if the undelayed release trips.

The parameters to be taken into account are:

- loop resistance ($R_i + R_L$)
(R_i = internal resistance MCB at 20 °C/ 63 °F and R_L = output resistance at 20 °C / 63 °F)
- copper temperature: 80 °C / 176 °F in the case of a short circuit / voltage drop, contact resistance
- **Result: a total derating factor of 2/3**

example 1: standard power supply unit

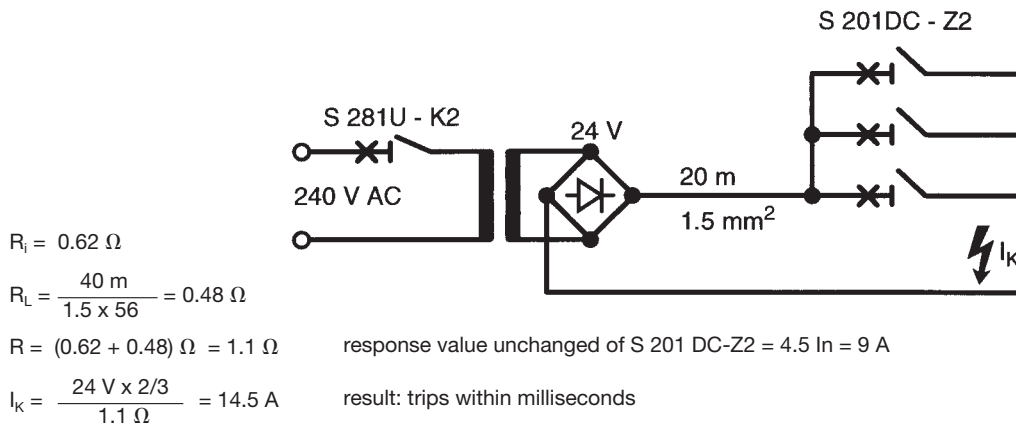

2CDC 022 419 F0003

example 2: switched mode power supply unit

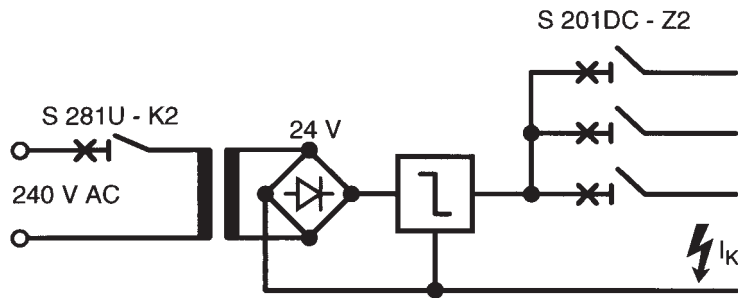

2CDC 022 420 F0003

MCB S 201 needs < 100 ms for undelayed tripping. If the switched mode power supply unit adjusts downwards undelayed when a short circuit occurs, the PSU adjusts quicker than the S 201... is able to respond.

consequence: no selective fault recognition.

result: The output of the switched mode PSU must adjust in a delayed mode (> 100 ms) and the protection device must be adapted to this delayed reduced value in order to ensure selective fault recognition.

example for admissible voltages between conductors

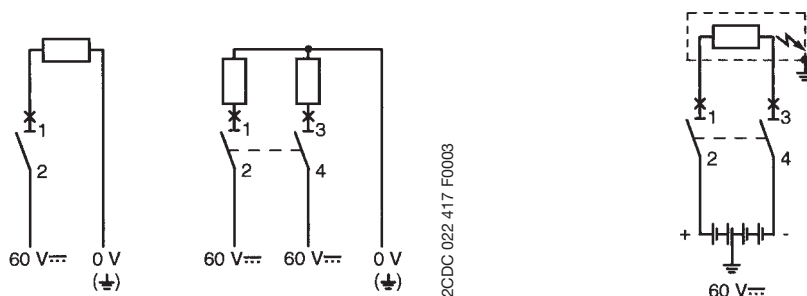

2CDC 022 417 F0003

2CDC 022 416 F0003

Technical Data

specifications:	DIN VDE 0641 -11, IEC 60898, EN 60898, VDE 0660 -101 IEC 60947-2, EN 60 947 -2, UL 489
No. of poles:	1
trip characteristics:	K, Z
rated current I_n :	K and Z 1 ... 25 A
rated voltage U_n :	1-pole 60 V DC / 60 V AC
min. operating voltage U_{Omin} :	12 V-
rated switching capacity:	10 kA
insulation coordination:	according to DIN VDE 0110 Part 1 und 2
– overvoltage category:	III
– pollution degree:	2
– surge voltage U_{imp} (1.2/50 μ s):	4 kV (test voltage 6.2 kV at N.N., 5 kV at 2000 m)
– surge alternating voltage:	2.5 kV (50/60 Hz)
housing:	insul. mat. group I (CTI \geq 600) acc. to DIN IEC 112/VDE 0303 Part 1, RAL 7035
operating lever:	insulating material group II (400 \leq CTI < 600) black, sealable
protection according to DIN VDE 0100:	IP 20, in the consumer unit IP 40
degree of protection:	IP XXB
design:	according to DIN 43880, size code 1
depth:	68 mm
overall dimensions w x h x d:	17.5 x 85 x 69 mm (with auxiliary contact 17.5 x 102.5 x 69)
mounting position:	optional
fixing:	snap-on on top-hat rail EN 60 715, 35 mm screw fixing onto mounting rail
connection:	bi-directional cylinder lift terminal (two-terminal chamber) at top and bottom. Suitable for the connection of single, multi- or finely stranded conductors up to 25 mm ² (with simultaneous busbar connection)
tightening torque:	2.5 Nm
mechanical service life :	20.000 switchovers
service life at rated load	20.000 switchovers
climatic resistance	constant climate 23/73/83, 40/104/93, 55/131/20 [°C/°F/RH]
according to DIN IEC 68 Part 2-30:	alternating climate 25/77/95 - 40/104/93 [°C/°F/RH]
storage temperature:	$T_{max} + 70$ °C/ 158 °F, $T_{min} - 40$ °C/- 40 °F
ambient temperature:	$T_{max} + 55$ °C/ 131 °F, $T_{min} - 25$ °C/- 13 °F
shock protection:	30 g, at least 2 impacts impact duration 13 ms
vibration resistance	
according to DIN IEC 68-2-6:	5 g, 20 frequency cycles 5 ... 150 ... 5 Hz at 0.8 I_n

Technical data of the integrated auxiliary contact

contact complement:	1NO (1 normally open) 1NC (1 normally closed)
contact rating:	DC 12 identical DC 13 DC 13 30 V 2 A, 50 V 1 A
min. contact load:	24 V, 4 mA
min. rated voltage:	12 V AC/DC at 0.1 VA
short circuit protection:	with S 201 DC-K2 or -Z2
electrical service life:	> 4000 switchovers
safe disconnection of auxiliary circuit and main circuit according to VDE 0106 Part 101	
connection capacity:	0.75 up to 2.5 mm ² (use connector sleeves for finely-stranded conductors)
tightening torque:	0.5 Nm

Note: busbar system according to UL 489 under preparation

K-type trip characteristic

Reference temperature 20 °C/68 °F
Deviating ambient temperatures influence the tripping behaviour by 6% per 10 °C / 50 °F

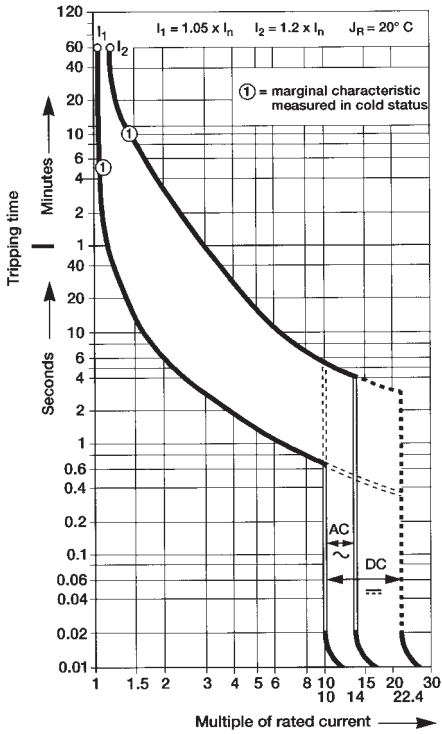

2CDC 022 194 F0205

Z-type trip characteristic

Reference temperature 20 °C/68 °F
Deviating ambient temperatures influence the tripping behaviour by 6% per 10 °C / 50 °F

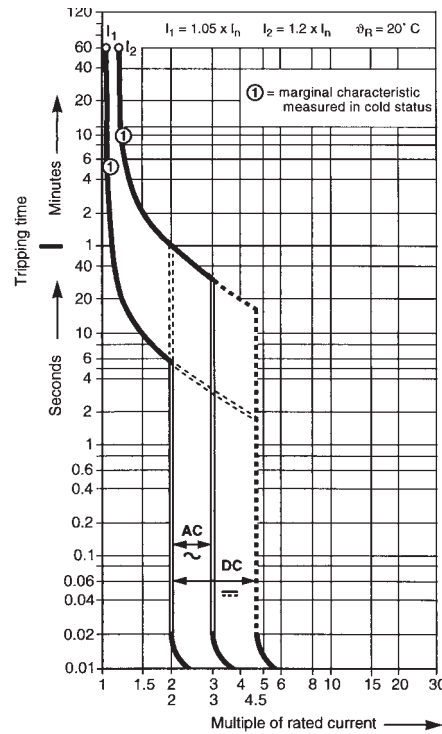

2CDC 022 428 F0203

Diagram of let-through values I²t of S 200-K

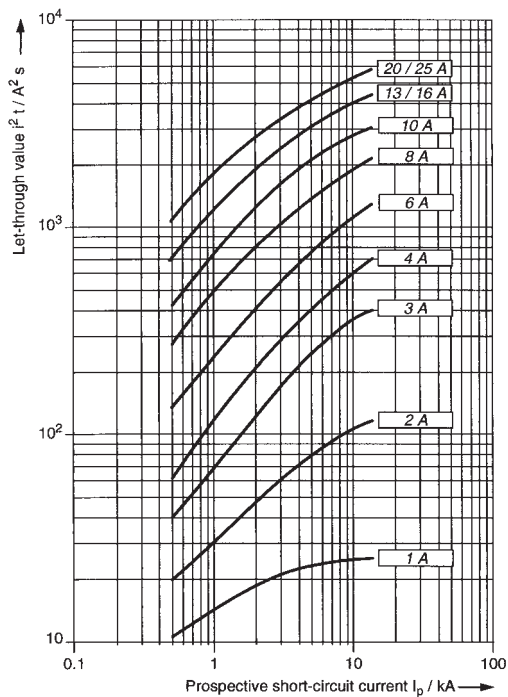

2CDC 022 422 F0203

Diagram of let-through values I²t of S 200-Z

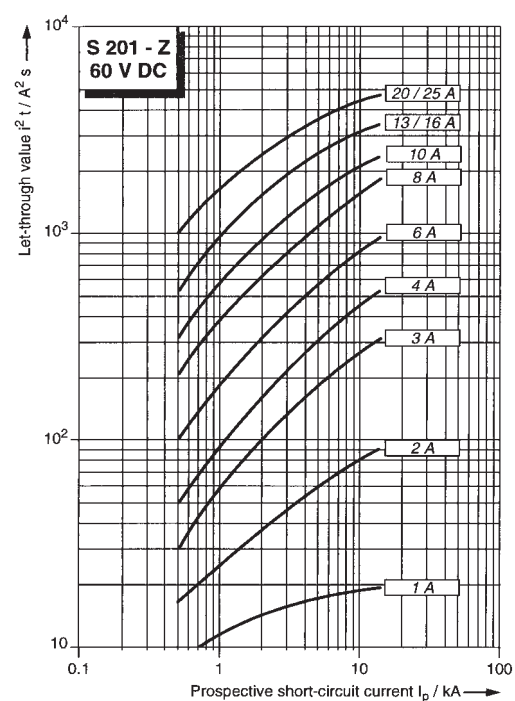

2CDC 022 486 F0203

Internal resistance and power loss of MCBs

Internal resistance per pole in mΩ, power loss per pole in W

type	rated current I_n A	cb series K		Z	
		mΩ	W	mΩ	W
S 200 DC	1	1550	1.6	2270	2.3
	1.6	695	1.8	1100	2.8
	2	460	1.9	619	2.5
	3	165	1.5	202	1.8
	4	120	2.0	149	2.4
	6	52	1.9	104	3.7
	8	38	2.5	53.9	3.45
	10	12.6	1.26	17.5	1.7
	13	12.6	1.26	-	-
	16	7.7	2.0	10.9	2.8
	20	6.7	2.7	6.0	2.4
	25	4.6	2.9	4.1	2.6

Dimensions of S 201 DC

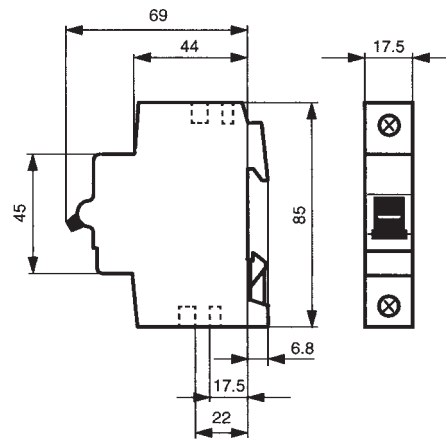

2CDC 022 415 F0003

Dimensions of S 201 DC.. H10

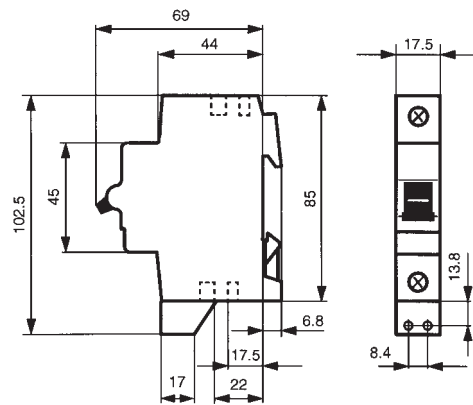

SK 0045 Z.01

Connection

Feeder optional from top or bottom, terminals designated according to EN 50 005



2CDC 022 418 F0003

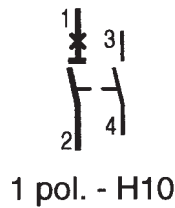

2CDC 022 429 F0003

Technical data

Specifications:

UL File-Number:

No. of poles:

tripping characteristics:

rated current I_n :

rated voltage U_n :

short circuit rupturing capacity:

frequency:

degree of protection:

mounting position:

fixing:

clamps only for Co:

service life,

mech. and at rated load:

tightening torque:

reference temperature:

ambient temperature:

shock resistance:

resistance to vibration acc. to IEC 60 068-2-6

S 200 U

UL 489, CSA C 22.2 No. 5, IEC 60 947-2

E 2123233

1, 2, 3 und 4

K and Z

0.2 (K) 0.5 (Z) ... 63 A

1-pole: 240 V AC

multipole: 240 V AC

10 kA

50/60 Hz

IP 20

optional

35 mm DIN rail

18 ... 4 AWG (0.75 ... 25 mm²)

20.000 operations

25 in. lbs (2.8 Nm)

25 °C

- 25 ... + 55 °C

10 g at least 2 impacts shock duration 13 ms

5 g, 20 frequency cycles, 5 ... 150 ... 5 Hz bei 0.8 I_n

S 200 UP

0.2 (K) 0.5 (Z) ... 25 A

1-pole: 277 V AC

multipole: 480 Y/277 V AC

These two equipment rows are calling oneself different rated current range, the rated voltage and the equipment measurement through hers.

Auxiliary contact S2C-H6RU and Signal contact S2C-S6RU for Miniature Moulded Case Circuit Breakers S 200 U and S 200 UP

rated current I_n :

rated voltage AC / DC:

short-circuit withstand capacity / 230 V AC:

insulation coordination:

- overvoltage category:

- surge voltage:

- pollution degree:

contact:

connection capacity mm²

tightening torque:

shock resistance acc. to DIN IEC 68-2-6:

mechanical service life :

dimensions:

10

24

1000 A bei S 201 K4

acc. to DIN VDE 0110 part 1 and 2

III

4 kV (1.2/50 μ s)

2

1 change over

0.75...2.5

1.2 Nm

5 g, 20 frequency cycles 5...150...5 Hz

at 24 V AC/DC, 5 mA auto-reclosing < 10 ms

10.000 operations

68 x 74 x 99 mm

AC 14	U_e	400V	230 V
	I_e	1 A	2 A

DC 12	U_e	220 V	110 V
	I_e	1 A	1.5 A

DC	U_e	60 V	24 V
	I_e	2 A	4 A

Shunt trip	Type		S 2C-A1 U		S 2C-A2 U			
	Rated voltage	AC	V	12 ... 60	110 ... 415	DC	V	12 ... 60
Max. release duration	ms		< 10		< 10			
Min. release voltage	AC	V	7	55	DC	V	10	80
	Consumption on release		40 ... 200	55 ... 210	40 ... 200		55 ... 110	
Coil resistance	AC	VA	40 ... 200	55 ... 210	DC	VA	40 ... 200	55 ... 110
	Terminal resistance		3.7	225				
Terminals	mm ²		16					
Tightening torque	Nm		2					
Dimensions (H x D x W)	mm		100 x 69 x 17.5					

Undervoltage release	Type		S 2C-UA	S 2C-UA	S 2C-UA	S 2C-UA	S 2C-UA	S 2C-UA	S 2C-UA	S 2C-UA	S 2C-UA	
			12 DC	24 AC	24 DC	48 AC	48 DC	110 AC	110 DC	230 AC	230 DC	400 AC
Standards			IEC/EN 60947-1									
Rated voltage	AC	V	12	24	24	48	48	110	110	230	230	400
	DC	V										
Frequency	Hz		50 ... 60									
Release trip	V		0.35 UnOVO 0.7 Un									
Terminals	mm ²		2 x 1.5									
Consumption	VA		0.2	3.6	2	3.6	2.1	3.5	2.2	3.7	2.3	2.4
R esistance to corrosion	°C/RH		constant atmosphere: 23/83 - 40/93 - 55/20; variable atmosphere: 25/95 - 40/93									
Protection degree			IPXXB/IP2X									
Tightening torque	Nm		0.4									
Dimensions (H x D x W)	mm		85 x 69 x 17.5									

Short circuit rupturing capacity

series	trip characteristic	alternating current				Back-up ^① max. Fuse gG/gL
		1phase 120 V AC	240 V AC	2/3phase 240 V AC 120/240 V AC	400 V 277/480 V AC	
	A	kA/cos φ	kA/cos φ	kA/cos φ	kA/cos φ	
S 200 U-K, Z	0.2/0.5 ... 2	unlimited				not required
	3	10/0.25	10/0.25	10/0.25	10/0.25	25 A
	4, 5					35 A
	6					63 A
	8					80 A
	10 ... 20					100 A
	25, 30					125 A
32 ... 63	160 A					
S 200 UP-K, Z	0.2/0.5 ... 2	unlimited				not required
	3	10/0.25	10/0.25	10/0.25	10/0.25	25 A
	4, 5					35 A
	6					63 A
	8					80 A
	10 ... 20					100 A
	25					125 A

① Back-up protection is necessary only if the solid short-circuit current to be expected at the place of installation may exceed the switching capacity indicated.

Dimension drawings in mm

S 200 U

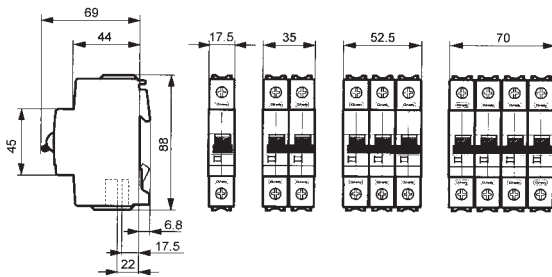

2CDC 022 291 F0004

S 200 UP

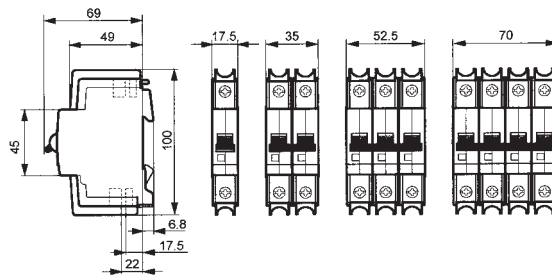

2CDC 022 218 F0004

S2C-H6RU, S2C-S6RU

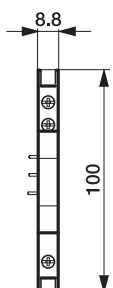

2CDC 092 045 F0005

S2C-A..U

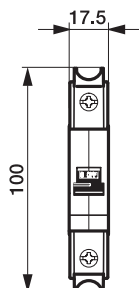

2CDC 092 050 F0005

Mounting

built-on of a S2C-H6RU

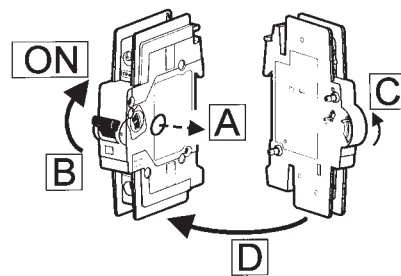

2CDC 022 290 F0004

built-on of a S2C-S6RU

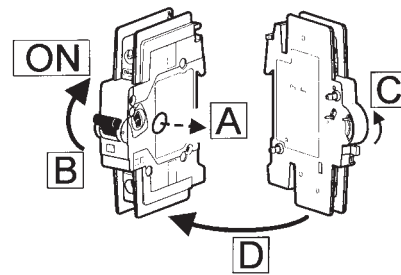

2CDC 022 289 F0004

built-on of a S2C-A..U

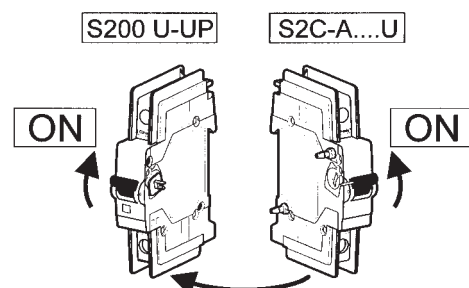

2CDC 022 578 F0004

Internal resistance and power loss of the Miniature Moulded Case Circuit Breakers

Internal resistance per pole in mΩ, power loss per pole in W

Type	rated current I_n A	device series		Z	
		K mΩ	W	mΩ	W
S 200 U S 200 UP	0.2	42500	1.7	–	–
	0.3	20000	1.8	–	–
	0.5	6340	1.6	10100	2.5
	0.75	2500	1.4	–	–
	1	1400	1.4	2270	2.3
	1.6	625	1.6	1100	2.8
	2	460	1.8	619	2.5
	3	211	1.9	211	1.9
	4	163	2.6	163	2.6
	6	67	2.4	104	3.7
	8	45	2.9	55	3.5
	10	19	1.9	21	2.1
	13	–	–	–	–
	16	8.2	2.1	10.9	2.8
	20	7.3	2.9	7.3	2.9
25	5.6	3.5	5.6	3.5	
32	4.1	4.2	4.1	4.2	
40	4.0	6.4	4.0	6.4	
50	1.2	3.0	1.8	4.4	
63	1.3	5.2	1.3	5.2	

Diagrams of let through values $I^2 t$ at 230/400 V AC

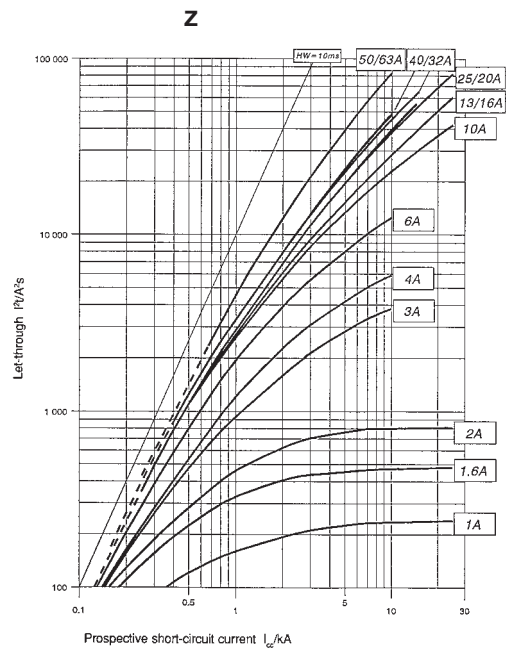
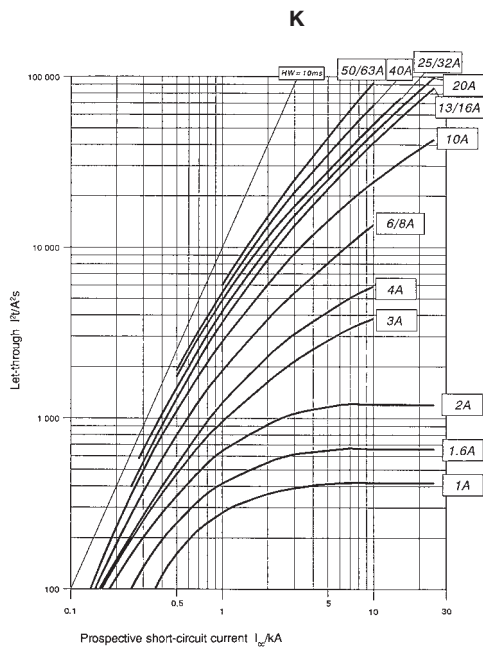

Tripping characteristic K

reference temperature 20 °C
The tripping device changes at a divergent ambient temperature by 6 % je 10 °C

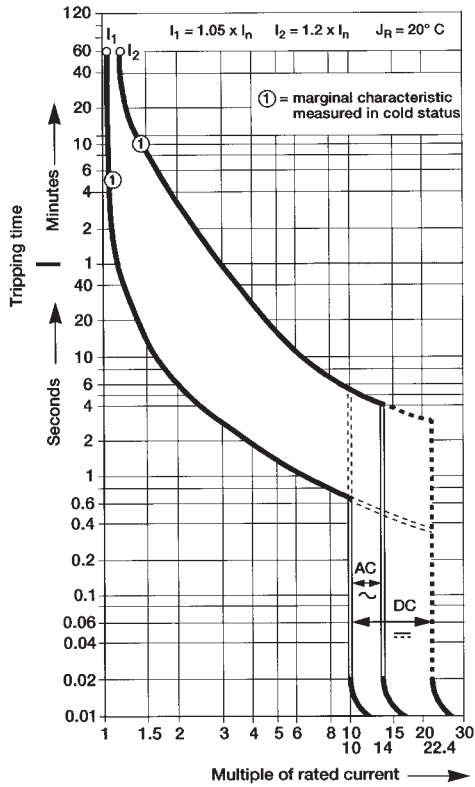

Tripping characteristic Z

reference temperature 20 °C
The tripping device changes at a divergent ambient temperature by 6 % je 10 °C

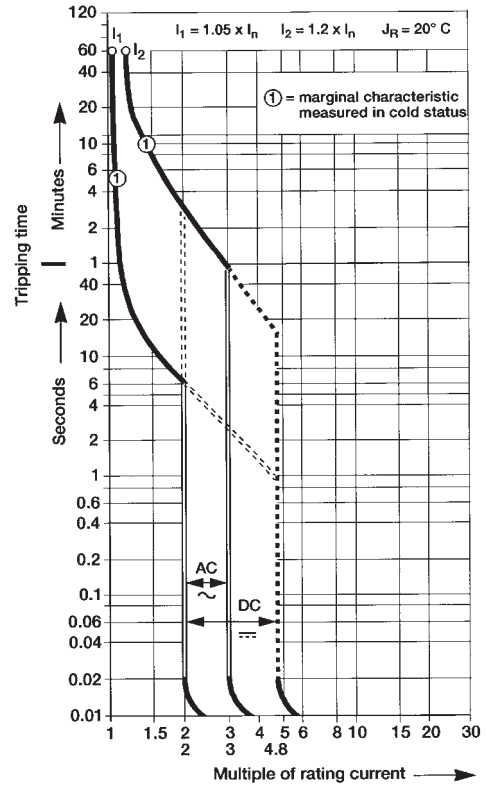

Max. operating current values depending on the ambient temperature for a circuit-breaker in load circuit of characteristics type K and Z

K and Z I _n (A)	Ambient temperature T (°C/°F)											
	-40	-30	-20	-10	0	10	20	30	40	50	60	70
0.5	0.66	0.64	0.61	0.59	0.56	0.53	0.50	0.47	0.43	0.40	0.35	0.31
1.0	1.32	1.27	1.22	1.17	1.12	1.06	1.00	0.94	0.87	0.79	0.71	0.61
1.6	2.12	2.04	1.96	1.88	1.79	1.70	1.60	1.50	1.39	1.26	1.13	0.98
2.0	2.65	2.55	2.45	2.35	2.24	2.12	2.00	1.87	1.73	1.58	1.41	1.22
3.0	4.0	3.8	3.7	3.5	3.4	3.2	3.0	2.8	2.6	2.4	2.1	1.8
4.0	5.3	5.1	4.9	4.7	4.5	4.2	4.0	3.7	3.5	3.2	2.8	2.4
6.0	7.9	7.6	7.3	7.0	6.7	6.4	6.0	5.6	5.2	4.7	4.2	3.7
8.0	10.8	10.2	9.8	9.4	8.9	8.5	8.0	7.5	6.9	6.3	5.7	4.9
10.0	13.2	12.7	12.2	11.7	11.2	10.6	10.0	9.4	8.7	7.9	7.1	6.1
13.0	17.2	16.6	15.9	15.2	14.5	13.8	13.0	12.2	11.3	10.3	9.2	8.0
16.0	21.2	20.4	19.6	18.8	17.9	17.0	16.0	15.0	13.9	12.6	11.3	9.8
20.0	26.5	25.5	24.5	23.5	22.4	21.2	20.0	18.7	17.3	15.8	14.1	12.2
25.0	33.1	31.9	30.6	29.3	28.0	26.5	25.0	23.4	21.7	19.8	17.7	15.3
32.0	42.3	40.8	39.2	37.5	35.8	33.9	32.0	29.9	27.7	25.3	22.6	19.6
40.0	52.9	51.0	49.0	46.9	44.7	42.4	40.0	37.4	34.6	31.6	28.3	24.5
50.0	66.1	63.7	61.2	58.6	55.9	53.0	50.0	46.8	43.3	39.5	35.4	30.6
63.0	83.3	80.3	77.2	73.9	70.4	66.8	63.0	58.9	54.6	49.8	44.5	38.6

Mutual thermal interference when an even load is applied at the same time.

A correction factor must be taken into account in the case of butt-mounted MCBs and an evenly applied, high load:
2 and 3 MCBs multiply with factor 0.9 / 4 and 5 MCBs with factor 0.8 / 6 and more MCBs with factor 0.75

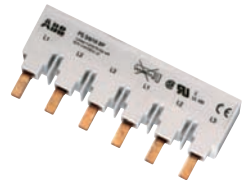

PS 3/6/16 BP

2CDC 061 423 F0004



SZ-BSK

SK 0100 B99

conn. capac. mm ²	No. of pins	phases	order details	bbn 40 16779 EAN	Cu-No.	price 1 pc. €	price group	weight 1 pc. kg	pack units pc.
			type code	order code					

UL approved busbars
Preassembled busbars not cutable

1-phase busbars, pin distance 17.6 mm, UL 489

16	6	1	PS 1/6/16 BP	2CDL 210 489 R1606	64496 9	0.035			1
16	12	1	PS 1/12/16 BP	2CDL 210 489 R1612	64497 6	0.070			1
16	18	1	PS 1/18/16 BP	2CDL 210 489 R1618	64498 3	0.105			1

2-phase busbars, pin distance 17.6 mm, UL 489

16	6	2	PS 2/6/16 BP	2CDL 220 489 R1606	64499 0	0.070			1
16	12	2	PS 2/12/16 BP	2CDL 220 489 R1612	64500 3	0.140			1
16	18	2	PS 2/18/16 BP	2CDL 220 489 R1618	64501 0	0.210			1

3-phase busbars, pin distance 17.6 mm, UL 489

16	6	3	PS 3/6/16 BP	2CDL 230 489 R1606	64502 7	0.110			1
16	12	3	PS 3/12/16 BP	2CDL 230 489 R1612	64503 4	0.221			1
16	18	3	PS 3/18/16 BP	2CDL 230 489 R1618	64504 1	0.332			1

Feeder terminals

for S 200 U

6 – 50	angled feeding	SZ-Ast 50 U	2CDL 200 489 R5001						
6 – 50	straight feeding	SZ-Ast 55 U	2CDL 200 489 R5002						

for S 200 UP

6 – 35	angled feeding	SZ-Ast 50 UP	2CDL 200 489 R3511						
6 – 35	straight feeding	SZ-Ast 55 UP	2CDL 200 489 R3512						

conn. capac. mm ²	module	phases	order details	bbn 40 16779 EAN	price 1 pc. €	price group	weight 1 pc. kg	pack units pc.
			type code	order code				

Shock-protection caps for PS... busbar blocks

	5-parts	SZ-BSK	2CDL 200 001 R0011	42000 6			0.003	10
--	---------	--------	--------------------	---------	--	--	-------	----

Ring-tongue terminal SZ-Ast 55UP RT

The terminal SZ-Ast 55UP RT is for connection of copper ring-tongue to our MCBs S200 UP.

Technical data SZ-Ast 55UP RT

Max. electrical load	100 A
Max. operating voltage	600 V AC
Max. torque	3 Nm
Insulation	Cycoloy C 2100 UL-V0

Use single UL listed or CSA certified insulated ring terminal only with max. width 0.46 inch (12 mm).

		SZ-Ast 55UP RT	2CDL 201 489 R0012	65011 3			0.011	50
--	--	----------------	--------------------	---------	--	--	-------	----

Dimension drawings in mm

Spacing: 17.6

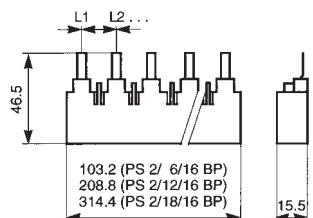



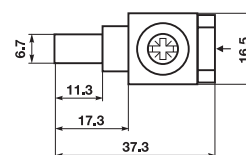
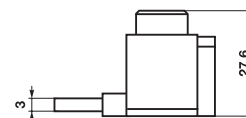
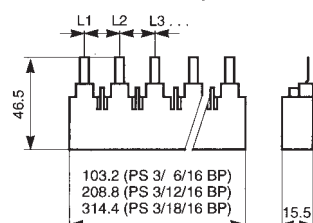





Spacing: 17.6

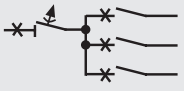

SZ-Ast 55UP RT

2CDC 062 130 F0005

Areas of application	S 200 S 200M	S201 DC	S 280 UC S 200 P	S 220	S 500	S 610	S 700 WT 63 ①
industrial networks  690 V~ 1000 V~				S 220	S 500 S 500 HV		WT 63
motor protection transformer 	S 200-K		S 200P-K	S 220-K	S 500-K	S 610-K	S 700-K
 USV 250 V~ to  photovoltaics 1200 V~			S 280 UC		S 500 UC		
semicon- ductor control circuits 24 V DC 	S 200-Z		S 200P-Z				
high discrimination 							S 700
disconnecter and main circuit breaker capabilities 			S 200 P	S 220	S 500	S 610	S 700
USA, Canada  1077  480 V AC 500 V DC	S 200		S 200 P S 280 UC	S 220	S 500		
USA, Canada  60 V DC/AC 240 V AC 480Y/277 V AC		S201 DC	S 200 U S 200 UP				
nautical classificationen GL LRS BV DNV	S 200		S 200 P S 280 UC	S 220	S 500	S 611 K (bis 63 A)	S700 (GL)
rated current switching capacity (230/400 V) I_{cn}/A I_n/A	6 000 10 000 ≤ 63	14 000 ≤ 25	25 000 ≤ 25	10000 ≤ 32	50000 ≤ 63	50 000 ≤ 100	25 000 ≤ 100
innovative cost reduction System pro M compact®	S 200 S 200M	S 201 DC	S 200 P				

① as selective group or full automat



ABB STOTZ-KONTAKT GmbH

P.O. Box 10 16 80, 69006 Heidelberg, Germany
Eppelheimer Straße 82, 69123 Heidelberg, Germany
Telephone +49-(0) 62 21-7 01-0
Telefax +49-(0) 62 21-7 01-723
www.abb.de/stotz-kontakt