

# PRODUCT DATASHEET

## DL SLIM DN 155 12 W 3000 K WT

DOWNLIGHT SLIM ROUND | Flat downlights with integrated driver, round shape



### Areas of application

- Direct replacement for luminaires with compact fluorescent lamps
- General illumination
- Public areas
- Stairways
- Corridors
- Foyers
- Shops

### Product benefits

- Very slim housing
- Low installation depth
- High luminous efficacy
- Energy savings up to 60 % (compared to luminaires that use CFL lamps)
- Very homogenous light
- Functional design
- Easy installation with fast connection
- Simple installation thanks to integrated driver

### Product features

- Small visible bezel
- Connector box with push wire terminal for tool-free connection



- Light guide made of non-yellowing PMMA for long lifetime

## TECHNICAL DATA

### Electrical data

Nominal wattage	12.00 W
Nominal voltage	220...240 V
Mains frequency	50...60 Hz
Nominal current	71.7 mA
Inrush current	15.6 A
Inrush current time $T_{h50}$	50 $\mu$ s
Max. number of luminaires per miniature circuit breaker B16	48
Max. number of luminaires per miniature circuit breaker C10	38
Max. number of luminaires per miniature circuit breaker C16	61
Power factor $\lambda$	0.50
Total harmonic distortion	< 20 %
Protection class	II
Operating mode	Integrated LED driver

### Photometrical data

Luminous flux	1020 lm
Luminous efficacy	85 lm/W
Color temperature	3000 K
Light color (designation)	Warm White
Color rendering index Ra	> 80
Standard deviation of color matching	< 6 sdc <sub>m</sub>
Luminous intensity	-
Flickering metric (Pst LM)	-
Stroboscope effect metric (SVM)	-
Photobiological safety group acc. to EN62778	RG0
Photobiological safety group acc. to EN62471	RG0
Beam angle	120 °

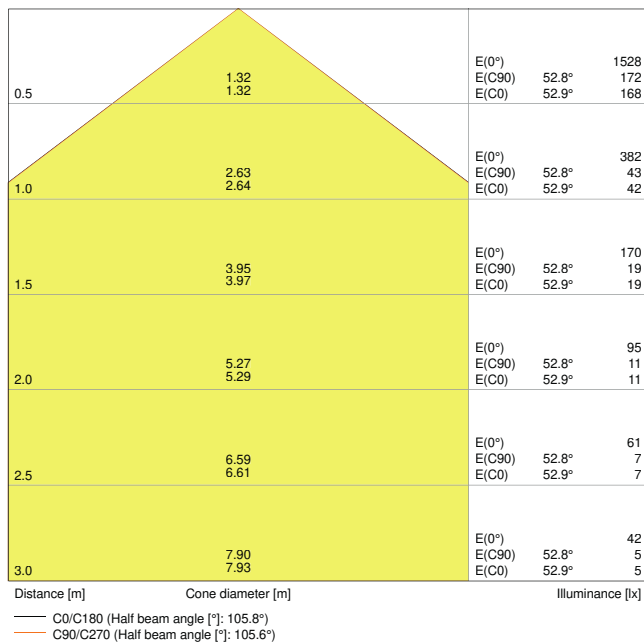

4058075052284 DL SLIM DN155 12W 3000K WT IP20

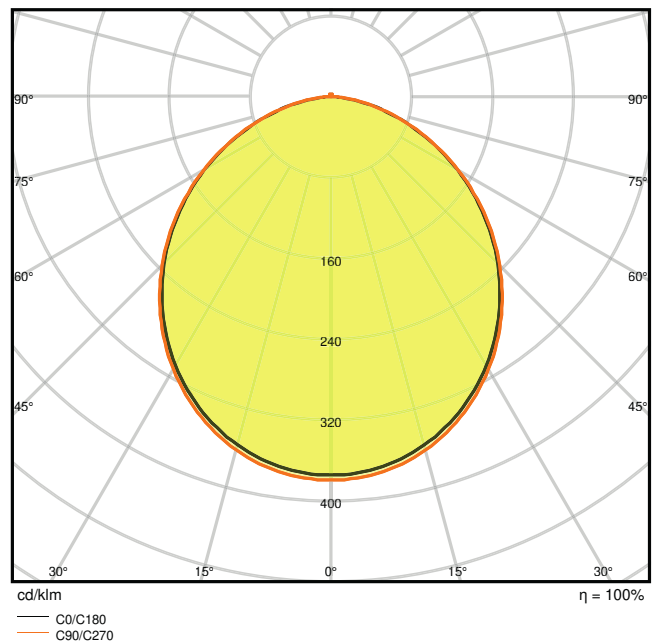

4058075052284 DL SLIM DN155 12W 3000K WT IP20

Dimensions & Weight

Diameter	169.00 mm
Height	30.00 mm
Product weight	272.00 g

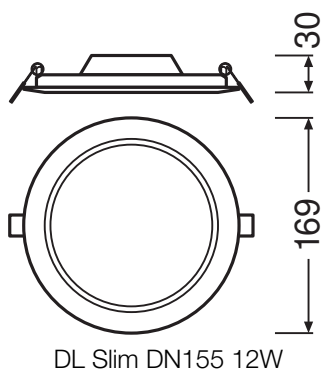

Materials & Colors

Product color	White
---------------	-------

Housing color	White
Body material	Polycarbonate (PC)
Cover material	Polycarbonate (PC)
Light emitting surface material	Polycarbonate (PC)
Glow Wire Test according to IEC 60695-2-12	650 °C
Mercury content	0.0 mg

### Application & Mounting

Ambient temperature range	-20...+50 °C
Temperature range at storage	-30...+70 °C
Type of connection	Screwless terminal, 2-Pole
Type of protection	IP20
Protection class IK (shock resistance)	IK03
Dimmable	No
Mounting type	Recessed
Mounting location	Ceiling
Application environment	Indoor
Mounting diameter	155,0 mm
Mounting depth	50,0 mm
LED module replaceable	Not replaceable
With light source	Yes

### Lifespan

Lifespan L70/B50 at 25 °C	30000 h <sup>1)</sup>
Lifespan L80/B10 at 25 °C	20000 h <sup>1)</sup>
Lifespan L90/B10 at 25 °C	12000 h
Number of switching cycles	50000

<sup>1)</sup> t[h]: L70 / B50 @ 25 °C (Ta), t[h]: L80 / B10 @ 25 °C (Ta), t[h]: L90 / B10 @ 25 °C (Ta)

### Control gear

Output current	180 mA
ECG - Output ripple current	< 6.5 %

### Certificates & Standards

Standards	CE / CB / EAC
Luminaire with limited surface temperature, "D sign"	No

Ball shot safe	No
----------------	----

Additional product data

Number of illuminants	Not relevant
-----------------------	--------------





Accessories Optional



Product image	Product name	EAN
	DL SLIM FRAME DN 155 WT	4058075079175







EQUIPMENT / ACCESSORIES

– Surface mounting frames available as accessories

DOWNLOAD DATA

	Documents and certificates	Document name
	Addon Technical Information	LSI DL SLIM
	Installation guide	User Instruction Downlight LED Slim
	On-Pack-Info	Legal Insert Downlight Slim
	Declarations Of Conformity CE	CE Certificate downlight Slim
	Declarations Of Conformity UKCA	DL SLIM WT IP20

	Photometric and lighting design files	Document name
	IES file (IES)	DL SLIM DN155 12W 3000K WT IP20
	LDT file (Eulumdat)	DL SLIM DN155 12W 3000K WT IP20
	ULD file (DIALux)	DOWNLIGHTSLIMROUND15512W3000KWT

Photometric and lighting design files		Document name
	ROLF file (RELUX)	DL SLIM DN155 12W-3000K
	UGR file (UGR table)	4058075052284 DL SLIM DN155 12W 3000K WT IP20
	LDC typ cone	4058075052284 DL SLIM DN155 12W 3000K WT IP20
	LDC typ polar	4058075052284 DL SLIM DN155 12W 3000K WT IP20
CAD/BIM files		Document name
	BIM_Revit_3D	Downlight Slim Round
	CAD_STEP_3D	DL SLIM DN 155
Tender texts		Document name
	Tender documents	DOWNLIGHT SLIM ROUND 155 12 W 3000 K WT-EN

LOGISTICAL DATA

Product code	Packaging unit (Pieces/Unit)	Dimensions (length x width x height)	Gross weight	Volume
4058075079038	Folding box 1	45 mm x 195 mm x 175 mm	323.00 g	1.54 dm <sup>3</sup>
4058075079045	Shipping box 6	290 mm x 205 mm x 195 mm	2158.00 g	11.59 dm <sup>3</sup>

The mentioned product code describes the smallest quantity unit which can be ordered. One shipping unit can contain one or more single products. When placing an order, for the quantity please enter single or multiples of a shipping unit.

ADDITIONAL CATALOG INFORMATION

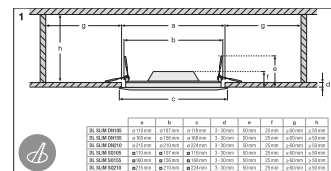
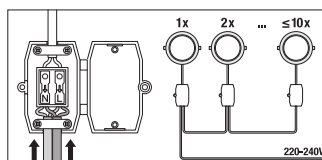
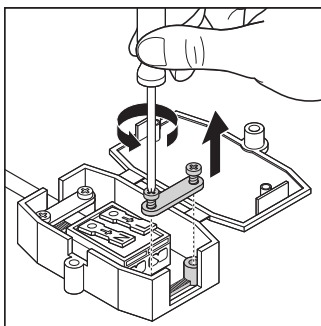

References / Links

– For Guarantee see [www.ledvance.com/guarantee](http://www.ledvance.com/guarantee)

---

## DISCLAIMER

Subject to change without notice. Errors and omission excepted. Always make sure to use the most recent release.