

# PRODUCT DATASHEET

## PL COMP 600 V 33W 840 U19 DALI

PANEL COMPACT 600 UGR<19 DALI | Square recessed panel luminaire with low glare, for 600 x 600 mm ceiling systems and DALI-2 technology

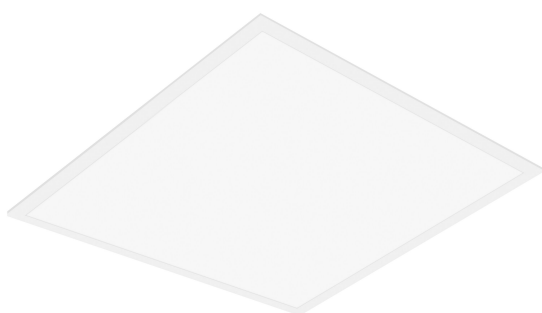

### Areas of application

- Direct replacement for luminaires with fluorescent lamps
- Offices, conference rooms
- Reception areas, foyers, corridors, elevators
- Suitable for recessed ceiling systems with grid size of 600 x 600 mm

### Product benefits

- Good glare reduction (UGR < 19)
- Low flicker light thanks to special electronic control gear
- External driver for extended flexibility and easy installation
- Suitable for emergency lighting
- 5 years guarantee

### Product features

- Suitable for central battery emergency installations acc. to EN 60598-2-22
- Push DIM function for dimming and switching directly on a pushbutton
- Extruded aluminum frame
- Polystyrene diffuser
- Lifetime (L80/B10): up to 50,000 h (at 25 °C)



## TECHNICAL DATA

### Electrical data

Nominal wattage	33.00 W
Nominal voltage	220...240 V
Mains frequency	0/50/60 Hz
Nominal current	190.000 mA
Inrush current	1.7 A
Inrush current time $T_{h50}$	52 $\mu$ s
Max. number of luminaires per miniature circuit breaker B16	83
Max. number of luminaires per miniature circuit breaker C10	52
Max. number of luminaires per miniature circuit breaker C16	83
Power factor $\lambda$	> 0.90
Total harmonic distortion	< 10 %
Protection class	II
Operating mode	External LED driver
Dimming interface	DALI-2

### Photometrical data

Luminous flux	3630 lm
Luminous efficacy	110 lm/W
Color temperature	4000 K
Light color (designation)	Cool White
Color rendering index Ra	> 80
Standard deviation of color matching	$\leq$ 5 sdc <sub>m</sub>
Low flicker	Yes
Flickering metric (Pst LM)	<1
Stroboscope effect metric (SVM)	< 0.4
Photobiological safety group acc. to EN62778	RG0
Beam angle	90 °
UGR	< 19

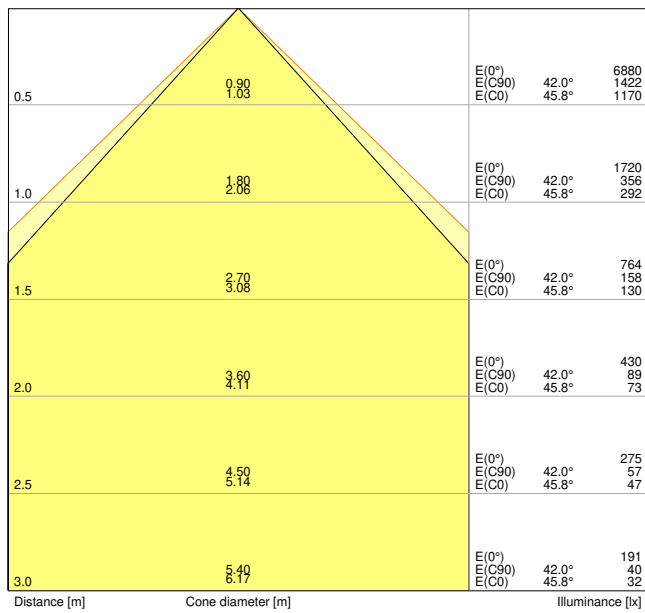

PL COMP 600 V 33W 840 U19 DALI EM CONVERSION BOX

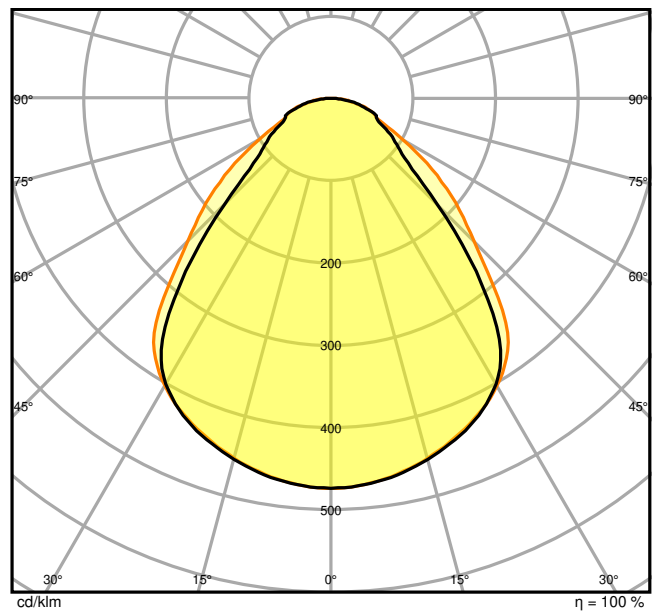

PL COMP 600 V 33W 840 U19 DALI EM CONVERSION BOX

Dimensions & Weight

Length	595.00 mm
Width	595.00 mm
Height	32.00 mm
Product weight	1790.00 g

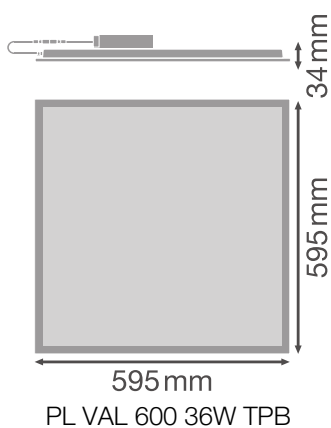

## Materials & Colors

Product color	White
Housing color	White
Body material	Steel
Cover material	Polystyrene (PS)
Light emitting surface material	Polystyrene
Glow Wire Test according to IEC 60695-2-12	650 °C
Mercury content	0.0 mg

## Application & Mounting

Ambient temperature range	-10...+45 °C
Temperature range at storage	-20...+70 °C
Type of connection	Screwless terminal, 4-Pole (L,N, DA+, DA-)
Type of protection	IP40/IP20
Protection class IK (shock resistance)	IK02
Dimmable	Yes
Type of dimming	DALI2
Mounting type	Recessed/Suspended/Surface
Mounting location	Ceiling
Application environment	Indoor
Mounting length	575 mm
Mounting width	575 mm
Mounting depth	50,0 mm
Adjustable	No
With light source	Yes

## Lifespan

Lifespan L70/B50 at 25 °C	70000 h <sup>1)</sup>
Lifespan L80/B10 at 25 °C	50000 h <sup>1)</sup>
Lifespan L80/B50 at 25 °C	50000 h
Lifespan L90/B10 at 25 °C	40000 h
Number of switching cycles	50000

<sup>1)</sup> t[h]: L70 / B50 @ 25 °C (Ta), t[h]: L80 / B10 @ 25 °C (Ta), t[h]: L90 / B10 @ 25 °C (Ta)

## Control gear

Output current	700 mA
----------------	--------

ECG - Output ripple current	< 7 %
ECG - Length	168 mm
ECG - Width	49.9 mm
ECG - Height	32 mm
Recommended control gear	LEDV DR DALI-P-44/220-240/1050; Tridonic LCA 45W 500-1400mA one4all SC PRE

### Emergency lighting

Wattage in emergency operation mode	5 W
Luminous flux in emergency operation mode	400 lm





### Certificates & Standards





Standards	CE / CB / TÜV / UKCA / EAC / EPD
Luminaire with limited surface temperature, "D sign"	No
Ball shot safe	No
Replaceable light source (EPREL)	Not replaceable

### Additional product data

Added function	VIVARES
BEG subsidy	No

### Accessories Optional



Product image	Product name	EAN
	DR DALI - P -44/220-240/1050	4058075779723
	DR AY ZB+DALI CLAMP DUO	4058075483125
	EM CONVERSION BOX	4058075237025
	PANEL 600 SURFACE MOUNT KIT H75	4058075472914





Product image	Product name	EAN
	PANEL 600 SURFACE MOUNT KIT H70 VAL	4058075402843
	PANEL RECESSED MOUNT CLIPS VAL 4x	4058075409859
	PANEL 600 RECESSED MOUNT FRAME	4058075402881
	PANEL Suspension Kit	4058075402928
	CONNECTOR BOX 5POLE L/N/PE/D+/D- 4x	4058075473034







### EQUIPMENT / ACCESSORIES



- Accessories for several mounting options available
- Security rope for luminaire included
- Security brackets preinstalled
- External control gear included
- Suitable for use with separate Emergency Conversion Box
- Connector box with 5-pole terminal for through-wiring separately available for cable cross sections up to 2.5 mm<sup>2</sup>

### DOWNLOAD DATA

Documents and certificates	Document name
 User instruction / safety instructions	PANEL COMPACT DALI
 Legal information	LISO Insert PL COMP 600 V
 Legal information	Legal Insert PANEL COMPACT

Documents and certificates		Document name
	Legal information	EM Insert PL COMP
	Legal information	Informationstext 18 Abs 4 ElektroG
	Declarations of conformity	CE Declaration of Conformity PL COMP V DALI
	Declarations of conformity UKCA	UKCA Declaration of Conformity PL COMP V DALI

Photometric and lighting design files		Document name
	IES file (IES)	PL COMP 600 V 33W 840 U19 DALI EM CONVERSION BOX
	LDT file (Eulumdat)	PL COMP 600 V 33W 840 U19 DALI EM CONVERSION BOX
	ULD file (DIALux)	PL COMP 600 V 33W 840 U19 DALI
	ROLF file (RELUX)	PL COMP 600 V 33W 840 U19 DALI
	UGR file (UGR table)	PL COMP 600 V 33W 840 U19 DALI EM CONVERSION BOX
	Light distribution curve type cone	PL COMP 600 V 33W 840 U19 DALI EM CONVERSION BOX
	Light distribution curve type polar	PL COMP 600 V 33W 840 U19 DALI EM CONVERSION BOX

CAD/BIM files		Document name
	BIM Revit 3D	Panel Compact
	CAD STEP 3D	PL COMP 600

Tender texts		Document name
	Tender documents	PANEL COMPACT 600 UGR19 DALI 33W 840 U19 DALI-EN

**LOGISTICAL DATA**

Product code	Packaging unit (Pieces/Unit)	Dimensions (length x width x height)	Gross weight	Volume
4099854017261	Folding box 1	37 mm x 600 mm x 660 mm	2154.00 g	14.65 dm <sup>3</sup>

Product code	Packaging unit (Pieces/Unit)	Dimensions (length x width x height)	Gross weight	Volume
4099854017278	Shipping box 4	680 mm x 168 mm x 625 mm	9546.00 g	71.40 dm <sup>3</sup>

The mentioned product code describes the smallest quantity unit which can be ordered. One shipping unit can contain one or more single products. When placing an order, for the quantity please enter single or multiples of a shipping unit.

### ADDITIONAL CATALOG INFORMATION

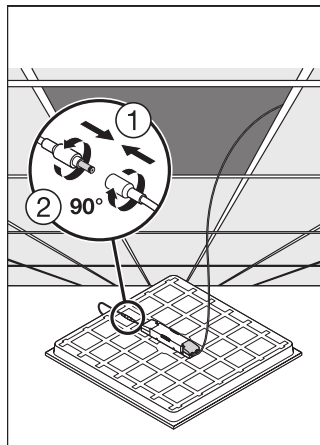
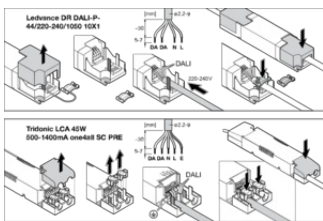

### References / Links

– For Guarantee see [www.ledvance.com/guarantee](http://www.ledvance.com/guarantee)

### DISCLAIMER

Subject to change without notice. Errors and omission excepted. Always make sure to use the most recent release.