

PRODUCT DATASHEET

PL SF 1574 V 48W ML 93040 U19

PANEL SURFACE 1574 | Surface-mounted refurbishment luminaires, 1574 x 374 mm



Areas of application

- Offices, conference rooms
- Reception areas, foyers, corridors

Product benefits

- Rectangular refurbishment luminaire for replacing standard T5 and T8 surface-mounted luminaires
- Enlarged luminaire dimensions to cover mounting marks of existing luminaire
- Highly versatile due to selectable lumen levels and light colors (Multi Select)
- Through-wiring possible with included connector box
- Easy mounting by single person
- Versions with reduced glare (U19) for office applications available

Product features

- High color rendering (CRI > 90) with up to 130 lm/W
- Robust one-piece metal frame
- Polystyrene diffuser
- High color consistency: ≤ 3 SDCM



TECHNICAL DATA

Electrical data

Nominal wattage	48 W / 39 W / 31 W
Nominal voltage	220...240 V
Mains frequency	50/60 Hz
Nominal current	205mA / 170mA / 135 mA
Inrush current	0.16 A
Inrush current time T_{h50}	121 μ s
Max. number of luminaires per miniature circuit breaker B16	23
Max. number of luminaires per miniature circuit breaker C10	17
Max. number of luminaires per miniature circuit breaker C16	28
Power factor λ	> 0.90
Total harmonic distortion	< 15 %
Protection class	II
Operating mode	External LED driver

Photometrical data

Luminous flux	6240 lm / 5265 lm / 4030 lm ¹⁾
Luminous efficacy	140 lm/W / 135 lm/W / 130 lm/W
Color temperature	3000 K / 4000 K
Reference control setting of contained light source (Kelvin)	4000 K
Light color (designation)	Warm White / Cool White
Color rendering index Ra	> 90
Standard deviation of color matching	3 sdcn
Low flicker	Yes
Flickering metric (Pst LM)	<1
Stroboscope effect metric (SVM)	< 0.4
Photobiological safety group acc. to EN62778	RG0
Beam angle	90 °
UGR	< 19

¹⁾ 6000 lm / 5070 lm / 4185 lm @3000K

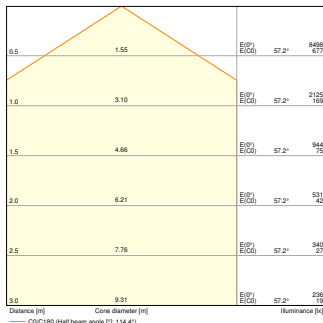

PL SF 1574 V 48W 930 U19
6240lm

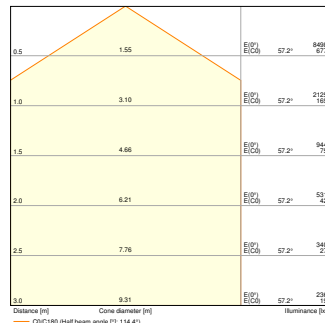

PL SF 1574 V 48W 940 U19
6240lm

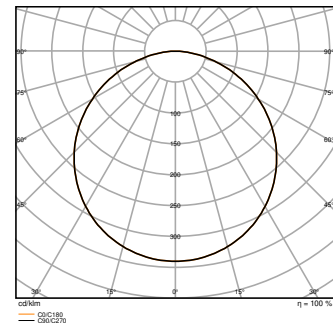

PL SF 1574 V 48W 930 U19
6240lm

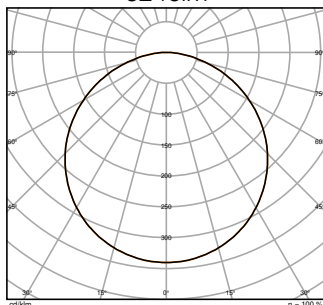

PL SF 1574 V 48W 940 U19
6240lm

Adjustable attributes

Nominal wattage	Color temperature	Luminous flux	Luminous efficacy
31 W	3000 K	4185 lm	135 lm/W
31 W	4000 K	4340 lm	140 lm/W
39 W	3000 K	5070 lm	130 lm/W
39 W	4000 K	5265 lm	135 lm/W
48 W	3000 K	6000 lm	125 lm/W
48 W	4000 K	6240 lm	130 lm/W

Dimensions & Weight

Length	1574.00 mm
Width	373.00 mm
Height	69.00 mm
Product weight	4940.00 g

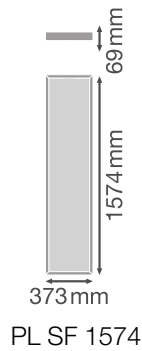

Materials & Colors

Product color	White
Housing color	White
RAL Color (most similar)	RAL 9003
Body material	Aluminum
Cover material	Polystyrene (PS)
Light emitting surface material	Polystyrene
Glow Wire Test according to IEC 60695-2-12	650 °C
Mercury content	0.0 mg

Application & Mounting

Ambient temperature range	-10...+40 °C
Temperature range at storage	-20...+70 °C
Type of connection	Screwless terminal, 2-Pole (L, N)
Type of protection	IP20
Protection class IK (shock resistance)	IK02
Dimmable	No
Mounting type	Surface/Suspended
Mounting location	Ceiling
Application environment	Indoor
Adjustable	No
With light source	Yes
Replaceable light source	No

Lifespan

Lifespan L70/B50 at 25 °C	100000 h ¹⁾
Lifespan L80/B10 at 25 °C	75000 h ¹⁾

Lifespan L80/B50 at 25 °C	75000 h
Lifespan L90/B10 at 25 °C	50000 h
Number of switching cycles	50000

1) t[h]: L70 / B50 @ 25 °C (Ta), t[h]: L80 / B10 @ 25 °C (Ta), t[h]: L90 / B10 @ 25 °C (Ta)

Control gear

Output current	1050 mA
ECG - Output ripple current	< 5 %
Recommended control gear	48W Constant Current LED Power

Emergency lighting

Type of Emergency Lighting (EL)	Optional EL unit (battery and controller) for decentral operation available separately
Type of emergency operation test	None
Wattage in emergency operation mode	5 W
Luminous flux in emergency operation mode	650 lm



Certificates & Standards

Standards	CE / CB / EAC / ENEC / ROHS / ERP / UKCA
Luminaire with limited surface temperature, "D sign"	No
Ball shot safe	No
Replaceable light source (EPREL)	Not replaceable

Additional product data

Product remark	Available from March 2026
Added function	MULTI SELECT

Accessories Optional

Product image	Product name	EAN
	PL SF SUSPENSION KIT L/E/N	4099854732003
	EL KIT COMP 55V 4W LI MT AT 3H WT	4058075860711











EQUIPMENT / ACCESSORIES











- Suspension kit available as separate accessory

Safety advice

- All electrical connections must be made by a qualified person.
- The external flexible cable or cord of this luminaire cannot be replaced; if the cord is damaged, the luminaire must be disposed of.
- Caution, risk of electric shock.
- The luminaires are not suitable for covering with thermally insulated material.

DOWNLOAD DATA

Documents and certificates		Document name
	User instruction / safety instructions	User Instruction G11256010 PL SURFACE
	Legal information	Informationstext 18 Abs 4 ElektroG
	Legal information	Safety Insert G11207793
	Legal information	Legal Insert G11146927
	Legal information	PL SF
	Legal information	PL SF
	Declarations of conformity	PL SF
	Declarations of conformity UKCA	PL SF
Photometric and lighting design files		Document name
	IES file (IES)	PL SF 1574 V 48W 930 U19 6240lm
	IES file (IES)	PL SF 1574 V 48W 940 U19 6240lm
	LDT file (Eulumdat)	PL SF 1574 V 48W 930 U19 6240lm

Photometric and lighting design files		Document name
	LDT file (Eulumdat)	PL SF 1574 V 48W 940 U19 6240lm
	ULD file (DIALux)	PL SF 1574 V 48W ML 93040 U19
	ROLF file (RELUX)	PL SF 1574 V 48W ML 93040 U19
	UGR file (UGR table)	PL SF 1574 V 48W 930 U19 6240lm
	UGR file (UGR table)	PL SF 1574 V 48W 940 U19 6240lm
	Light distribution curve type cone	PL SF 1574 V 48W 930 U19 6240lm
	Light distribution curve type cone	PL SF 1574 V 48W 940 U19 6240lm
	Light distribution curve type polar	PL SF 1574 V 48W 930 U19 6240lm
	Light distribution curve type polar	PL SF 1574 V 48W 940 U19 6240lm
CAD/BIM files		Document name
	BIM Revit 3D	Panel-Surface
	CAD STEP 3D	PL SF 1574

LOGISTICAL DATA

Product code	Packaging unit (Pieces/Unit)	Dimensions (length x width x height)	Gross weight	Volume
4099854730542	Folding box 1	77 mm x 1,588 mm x 381 mm	5525.00 g	46.59 dm ³
4099854730559	Shipping box 2	1,606 mm x 175 mm x 410 mm	12493.00 g	115.23 dm ³

The mentioned product code describes the smallest quantity unit which can be ordered. One shipping unit can contain one or more single products. When placing an order, for the quantity please enter single or multiples of a shipping unit.

ADDITIONAL CATALOG INFORMATION

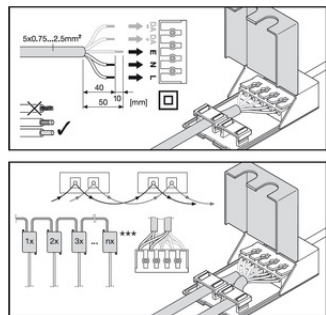
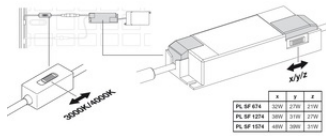

PANEL SURFACE	DRIVER	W	h _{max} [mm]	h _{min}	h _{tot} /W
PL SF 674	PL SF 674 940 (+SNP)	32	700	4160	130
		27	600	3645	135
	21	470	2340	140	
	PL SF 674 930 (+SNP)	32	700	4000	125
		27	600	3510	130
	21	470	2825	135	
PL SF 674 DA 940	DR DALI-P-42/220-240V-1A0 EAN 4058075640381	32	700	4160	130
		30	700	4000	125
	DR ZIGBEE NF P-48W 220-240V 1A2 EAN 409985466878	32	700	4160	130
		30	700	4000	125
PL SF 1274	PL SF 1274 940 (+SNP)	31	700	4020	130
		27	600	3645	135
	38	850	4750	125	
	31	700	4030	130	
	PL SF 1274 930 (+SNP)	27	600	3510	130
		38	850	4000	120
PL SF 1274 DA 940	DR DALI-P-42/220-240V-1A0 EAN 4058075640381	38	850	4000	120
		38	850	4750	125
	DR ZIGBEE NF P-48W 220-240V 1A2 EAN 409985466878	38	850	4000	120
		38	850	4750	125
PL SF 1574	PL SF 1574 940 (+SNP)	48	1050	6240	130
		38	900	5265	135
	51	700	3345	140	
	PL SF 1574 930 (+SNP)	48	1050	6000	125
		31	700	4185	130
	PL SF 1574 DA 940	DR DALI-P-42/220-240V-1A0 EAN 4058075640381	48	1050	6240
48			1050	6000	125
DR ZIGBEE NF P-48W 220-240V 1A2 EAN 409985466878		48	1050	6240	130
		48	1050	6000	125

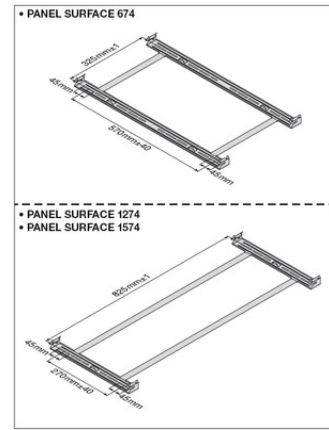

References / Links

- For Guarantee see www.ledvance.com/guarantee

DISCLAIMER

Subject to change without notice. Errors and omission excepted. Always make sure to use the most recent release.